

**Positive Displacement
Pumps, Inline Macerators
& Distributing Products**

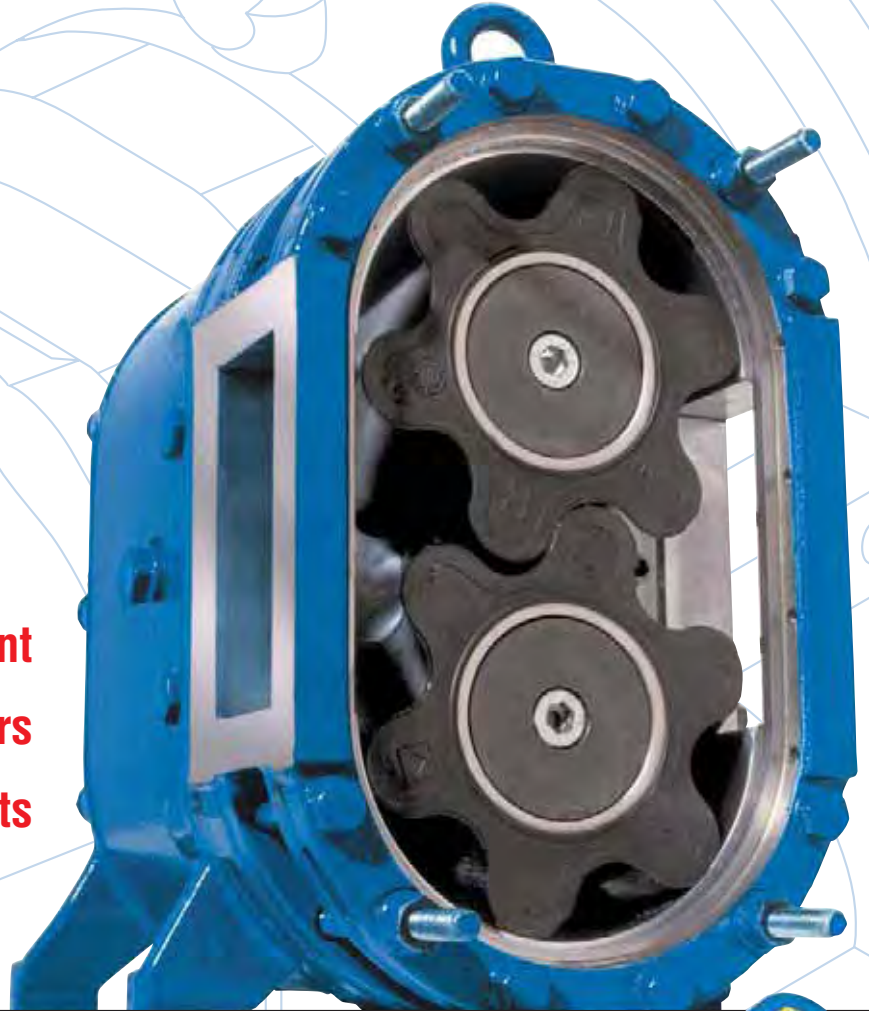

 **VOGELSANG**



An ISO9000 2001 Certified Manufacturing Company

Innovation & Quality

Application Engineering

Since 1929, Vogelsang has been providing the right product for the job. Staffed with seasoned, professional application engineers, Vogelsang will assist you in the selection of the correct product and configuration for all your municipal, industrial, and agricultural needs.

Design & Engineering

Our products can be modified and combined to fit specific requirements. Our design team will create a system that will achieve your goals. Our engineering staff will ensure your new system works flawlessly.

Quality Custom Construction

Our production team will configure your equipment to work within your existing facility as directed by our engineers. We offer the highest standard of construction and materials to ensure you get the most life possible out of our products.

Cutting Edge Materials

Every application of our products has an ideal set of materials to optimize capacity and minimize wear. Wherever there is contact or friction between moving parts, we have developed combinations of materials that will optimize the life of the equipment for your specific needs. This benefits you both in extended equipment life, and reduced operation and maintenance cost.

Versatility

Our products can be configured and combined in a variety of ways to meet your demands. The versatility of our products makes it possible to get them into small areas with limited accessibility. Our HiFlo Rotary Lobe pumps are typically smaller than a traditional progressing cavity pump of the same capacity. This makes it possible to get them into areas where others simply won't fit.

Service & Commitment

In-Line Service

Servicing of the wet-end of our products is done without removal of equipment. In-line service means quicker repairs, less downtime, and reduced labor costs.

Parts Availability

With the support of over 100 worldwide distributors, spare parts and trained service professionals are just around the corner.

Customer Service

Our relationship doesn't end with the sale. Expect quick and expert advice about our products once they're in place. When you need service or maintenance, we'll be there on time to get the job done right.

Lifeguard

Lifeguard represents our mission to create the best products in the industry. Continued research and development has made it possible to overcome the weaknesses of traditional pumping equipment. We've overcome these problems by employing better design and materials. The results are longer life and less frequent service than traditional pumps. Wherever you see a lifeguard icon is a problem area that we've researched and made better.

Warranty

Our confidence in our products shows in our warranty. Our standard warranty is 2 years, 100% parts and labor, including wear parts, such as mechanical seals, lobes, bearings, cutting screens, blades etc. If your equipment goes down, we get you back up and running as quickly as possible. The combination of a great warranty and easily maintained equipment gives you worry-free service.



How our pumps work

HiFlo, 100% pulsation-free rotors are driven on each shaft by external timing gears to rotate in opposite directions. The motion of the rotors creates an expanding cavity on the inlet side to allow fluid to flow into the pump chamber. The rotors carry the fluid around the housing segments to the outlet side, where it is forced out of the pump as the cavity contracts. Flow is controlled by the speed of the pump, and its displacement per revolution.

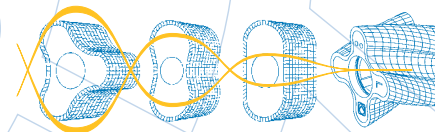

Pulsation-Free Pumping

The convoluted, specifically engineered geometric design of the HiFlo rotor allows for pulsation-free pumping through the entire range of operation. Its unique design is excellent for applications requiring low shear, highly entrained air, low to high viscosity products, and products requiring gentle solids handling.

HiFlo Innovation

Pumps designed for highly viscous liquids containing particles and debris.

Since 1929, Vogelsang has been a world leader, manufacturing a family of high quality, extremely dependable sludge handling and pumping products for the industrial, municipal, and agricultural markets of the world.

With the release of the HiFlo pulsation-free rotors, used exclusively in the Vogelsang positive displacement, rotary lobe pump, Vogelsang once again marked itself as an industry leader.

HiFlo's unique design allows for pulsation-free operation through the entire range of pumping.

Additional features include self-priming to 25' (8m), an ability to run dry for indefinite periods, pumping in either direction, while requiring no modifications to the pump, and a minimum of 25% more sealing lines per series, over conventional designs.

Coupled with Vogelsang's uniquely designed rotary lobe pump, the combination will allow flows from 5 to 6,000 gpm (1.1-1,363 m³/hr), and pressures to over 200 psi (15 bar).

Product viscosities from water to molasses are easily pumped with the HiFlo rotor. Power options include: electric, hydraulic or power take off.

When your application requires an affordable pump, that has low shear, high efficiency, low cost operation, an ability to pump highly entrained air and high solids content, you owe it to yourself to find out more about Vogelsang Pumps.



HiFlo Quick and easy access to internal parts with in-line wet-end rebuilds means minimal downtime without disturbing the piping.



HiFlo HiFlo rotary lobes provide pulsation-free pumping and longer wear than the competition, through our additional sealing lines.



HiFlo Adjustable housing segments provide an ability to bring the pump back into tolerance, in the event of wear, without purchasing spare parts.



HiFlo No step down shafts. We have maximized the diameter of our shafts in order to prevent wear to the seals and lobes caused by shaft deflection.

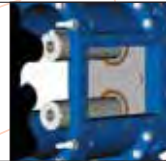

HiFlo Wear resistant, reversible internal wear plates maximize pump life and reduce service downtime.

HiFlo Applications

HiFlo Lobe Options

Depending on the series of pump you need, our exclusive HiFlo lobes come in four and six wing configurations.

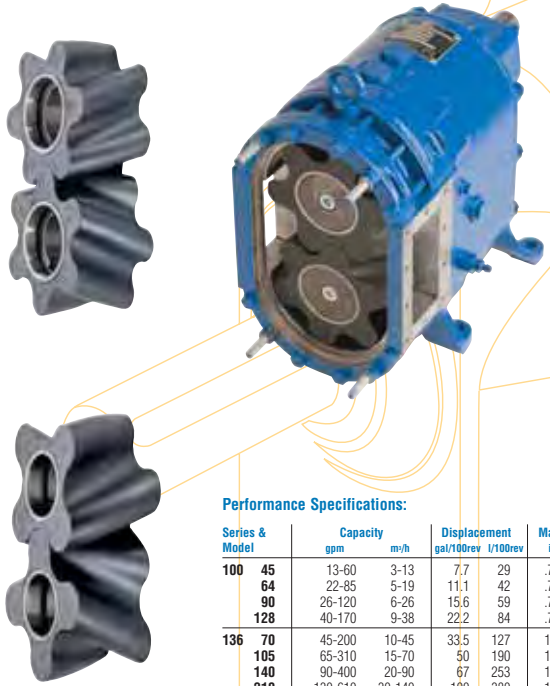

Accolades!

You've read what we think about our pumps, but what do our customers think? Below are examples of how we have increased efficiency, and reduced downtime and costs for our customers. You can find even more by visiting our website, www.vogelsangusa.com and choosing "success stories".

KB Compost, Akron, Ohio

"These pumps have reduced our operating costs significantly. All privately held wastewater operations should be using Vogelsang to reduce cost."

-Mel Kurtz, President Kurtz Brothers

City of Oil City, Pennsylvania

"Our Vogelsang pumps gravity thickened sludge to our Anaerobic Digesters. After a year of operation, they show no wear, and we are very satisfied with the pumps."

-Dick Curran, Foreman of Oil City WWTP

Andritz-Ruthner, Inc., Pittsburgh, Texas

"After extensive use of Vogelsang Rotary Lobe pumps in applications where our customers demanded uninterrupted service, I can say that Vogelsang pumps provided a trouble free solution to our pumping needs!"

-Carl Malkiewicz, Senior Project Manager

Performance Specifications:

Series & Model	Capacity		Displacement		Max Solids		Flange Size		Max Pressure		Speed rpm				
	gpm	m ³ /h	gal/100rev	l/100rev	in	mm	in	mm	Q: psi	bar	Q0: psi	bar			
100	45	13-60	3-13	7.7	29	.75	20	2.5	65	145	10	200-800			
	64	22-85	5-19	11.1	42	.75	20	3	80	131	9	200-800			
	90	26-120	6-26	15.6	59	.75	20	4	100	102	7	200-800			
128	40-170	9-38	22.2	84	.75	20	4	100	58	4	200-800				
136	70	45-200	10-45	33.5	127	1.5	40	4	100	145	10	174	12	150-650	800
	105	65-310	15-70	50	190	1.5	40	4	125	145	10	174	12	150-650	800
	140	90-400	20-90	67	253	1.5	40	6	125	116	8	174	12	150-650	800
	210	130-610	30-140	100	380	1.5	40	6	150	73	5	145	10	150-650	800
	280	180-800	40-180	134	506	1.5	40	6	150	116	8	150-650	650		
	420	260-1220	60-280	200	759	1.5	40	6	150	87	6	150-650	650		
186	92	90-440	20-100	94	356	2.5	61	6	125	145	10	100-600	600		
	130	130-640	30-145	133	503	2.5	61	6	150	145	10	174	12	100-600	600
	184	180-880	40-200	188	712	2.5	61	6	150	116	8	174	12	100-600	600
	260	260-1280	60-290	266	1006	2.5	61	8	200	73	5	145	10	100-600	600
	368	360-1760	80-400	376	1424	2.5	61	10	250	29	2	116	8	100-600	600
	390	390-1920	90-435	399	1509	2.5	61	10	250	29	2	102	7	100-600	600
	520	520-2560	120-580	532	2012	2.5	61	10	250	87	6	100-600	600		
	736	720-3520	160-800	752	2848	2.5	61	14	350	44	3	100-600	600		



Municipal & Industrial Wastewater

Designed for waste water applications, our pumps can be placed in a variety of positions throughout your facility. Applications include: Flocculate Metering, Sludge Dewatering to 18% Solids, Oil-Water Separation, DAF Sludge, Belt Filter Press and

Centrifuge Feed, Raw Sewage, Primary, Secondary, and Scum. Space saving and cost effective; as shown, compared to an existing progressing cavity pump, the photo exemplifies Vogelsang's size advantage on similar applications over the Progressing Cavity Pumps.



Industrial & Chemical Facilities

Our pumps can easily handle many applications in Industrial and Chemical Plants. Applications include: Chemicals, Coatings, Adhesives, Acids, Alkalines, Pastes, Emulsions, Feed Stock and Semi-Finished. Illustrated to the left, is a refinery application, pumping

number 6 fuel oil at 1500 gpm (341 m³/hr), at 110 psig (7.5 bar) from multiple holding tanks to waiting ships. The same pump is also run in reverse to unload the incoming ships.



Food Industry

There are many areas in food processing plants where our rotary lobe pumps offer outstanding performance. Applications include: Food Waste, DAF, Potato Pulp, Mash, Paste, Treacle, Blood, Train Oil, and many more. A typical food waste application shown, highlights the

advantage of Vogelsang's ability to pump DAF waste, loaded with solids, quickly and efficiently. The utilization of standard gooseneck flanges, allows for a suction lift of 25' (8m), and constant prime.



Wineries & Beverage Industry

HiFlo lobes are easy on grapes and other fruit pulp. The convoluted design, reduces liquid shear, and provides 100% pulsation-free operation. Applications include: Must, Pump Over, Leas, Pumace. Grape friendly

HiFlo Pumps, shown at a California "Jug Wine" producer, the Vogelsang pump processes more than 1,000 gpm (227 m³/hr) of must, leas, pumace or pump over, with the same pump.



Portable Applications

Our pumps travel well. Durability and compact size make Vogelsang pumps great for temporary on-site and liquid shipping applications. Applications include: Well Drilling Water, Construction Site Waste Liquids, Ship Building Bilge and Ballast Water. A light

and rugged HiFlo Pump, shown on a chemical tanker, Hamburg, Germany, is well suited for shipping chemicals, waste slurries, etc. Vogelsang advantages include PTO drive, forward and reverse pumping, and the ability to run dry.



Mills and Recycling Facilities

Perfect for pumping thick and acidic paper pulps and liquids containing adhesives, coatings, dyes, plastic chips and other fragments present during the recycling process. The HiFlo pump shown, is typical of our

Paper Mill applications, Pumping Stock, Coating, or White Water, Vogelsang is the competitive answer to the typical high priced competition.

RotaCut In-line Macerators

The ultimate in solids reduction - Engineered Technology to reduce solids, and protect downstream pumps and equipment

This high performance in-line macerator effectively reduces solids to specific size requirements, and reduces the costs associated with the operation of downstream equipment. Objects and debris suspended in liquid such as plastic fragments, rubber, hair, rags, applicators, plastic pens, string, wood, bones, etc. are drawn through the cutting screen and shredded by the self-sharpening rotary blades into an acceptable size for the downstream equipment to pass.

Optional cutter screen configurations provide the ability to condition solids to specific sizes, down to less than 1/4" (6mm).

Standard features include auto reverse, self-sharpening blades, and reusable cutter screens. RotaCut is 100% rebuildable in-line, which eliminates the need to send out a cutter cartridge for reconditioning.

Placed on the suction or discharge side of any manufacturer's pump, the RotaCut will eliminate ragging, reduce solids and protect down-stream equipment.

Protect pumps and dewatering equipment from clogging, prevent damage to belt press and plate and frame press applications, and more efficiently balance your centrifuge feed.

Choose a RotaCut when your application requires an affordable, high quality, in-line rebuildable macerator, to reduce cost and increase efficiency.

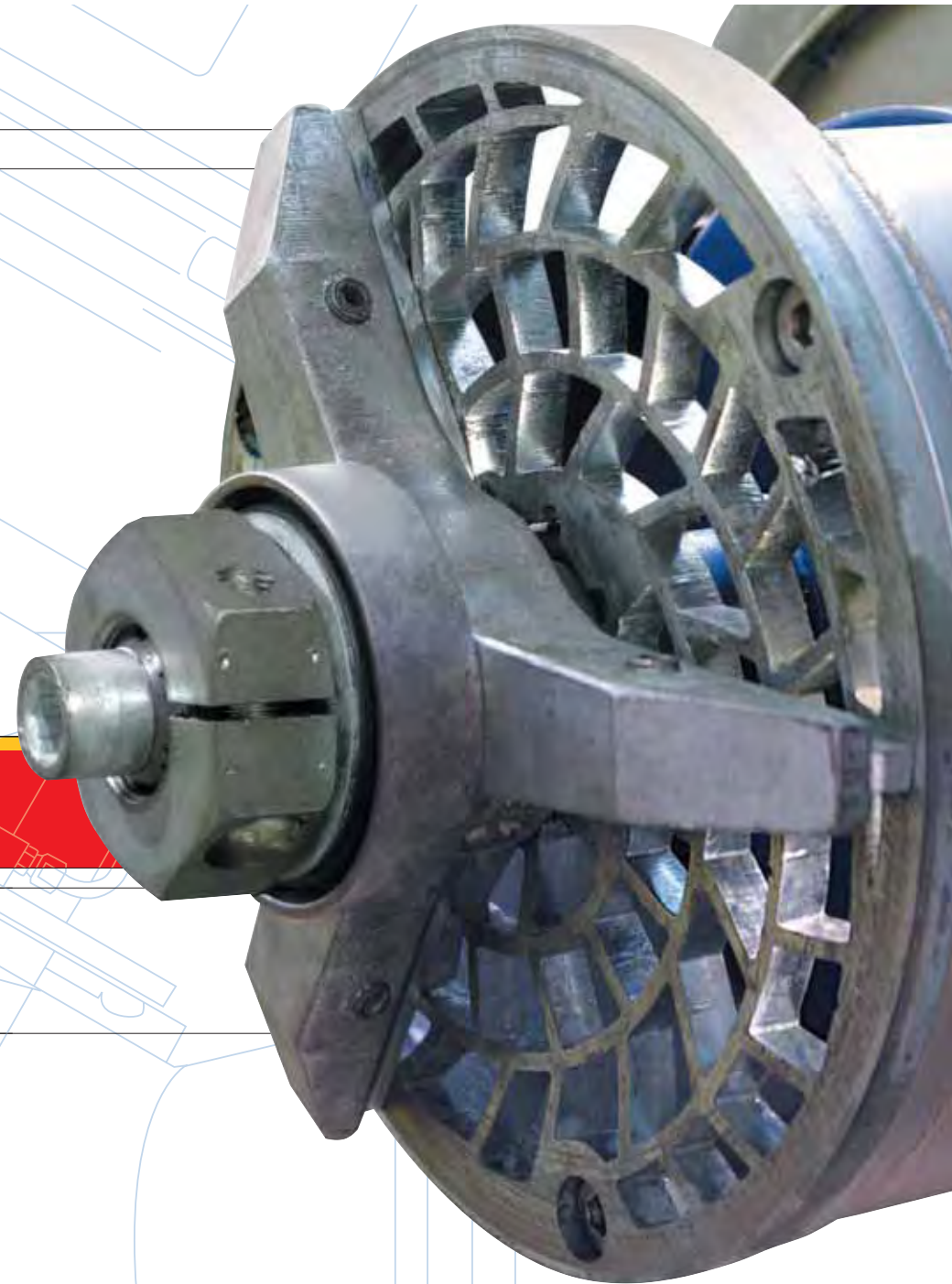

IFT In-line maintenance and blade replacement is made easy with quick access to cutting head. No need for costly cartridge replacement.



IFT The hardened steel, self-sharpening blades are attached to the shaft by pressure disks. This ensures proper contact between the blades and screen.



IFT The Automatic Reverse function enables the blades to automatically reverse the rotation if an object becomes lodged in the screen.



IFT The specially designed cutting screen is available in several different patterns to suit your specific application.



IFT Heavy objects such as metal fragments are collected in the flanged basin for easy removal.

RotaCut Applications

Optional Cutting Screens

Achieve a specific size of cut solid by selecting coarse to fine RotaCut cutting screens.

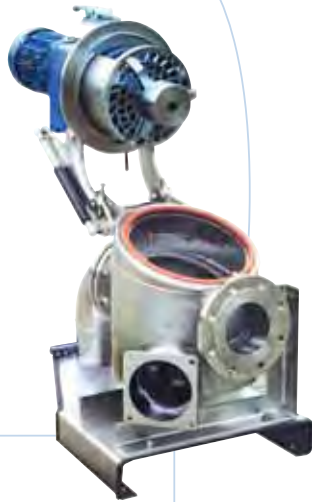
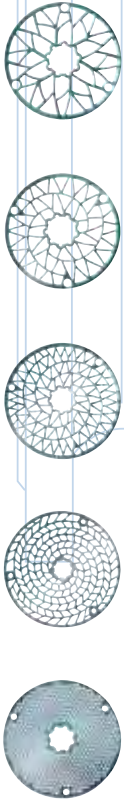

Performance Specifications:

Model	RotaCut 1500	RotaCut 3000	RotaCut 5000	RotaCut 10000
Motor Options	Geared Motor Hydraulic Motor	Geared Motor Hydraulic Motor	Geared Motor Hydraulic Motor	Geared Motor Hydraulic Motor
Optional Rotational Speeds rpm 1/min	78 159 318	76 177 330	76 177 318	66 171 317
Installed Power hp kW	1.5 / 1.1 3.0 / 2.2 3.0 / 2.2	2.0 / 1.5 3.0 / 2.2 3.0 / 2.2	2.0 / 1.5 3.0 / 2.2 5.0 / 3.0	3.0 / 2.2 7.5 / 5.5 10.0 / 7.5
Max Flow gpm m³/h	400 / 90	800 / 180	1300 / 300	2600 / 600
Max Pressure psi bar	30 / 2	30 / 2	30 / 2	30 / 2
Flange Size in mm	4 / 100	6 / 150	6 / 150	8 / 200

Accolades!

RotaCut inline macerators are quickly becoming more popular as an alternative to conventional twin shaft macerators due to their high performance, low cost and easy maintenance. Since we introduced the RotaCut in 1990, we've had hundreds of successful installations worldwide. During this time, our customers have enjoyed a product that lasts under the harsh conditions of a municipal or industrial facility.

You've read what we think about our macerators, and now here's what our customers think. Below are examples of how our in-line macerators have reduced downtime and costs for our customers. You can find even more by visiting our website, www.vogelsangusa.com and choosing "success stories".

Lewisburg, Pennsylvania

"We chose Vogelsang over the typical twin shaft macerator for its ease of maintenance. It's repairable in line, no more costly refurbished cartridges."

-Bill Dasher, Plant Manager

Delray Beach, Florida

"Delray Beach uses Vogelsang, because it performs flawlessly to our requirements and reduces our cost; that's the bottom line."

-Bob Hagel, Plant Manager



Municipal & Industrial Wastewater

In-line RotaCuts are frequently used on all aspects of waste water solids conditioning. From septage receiving at the front of the plant, to digester and clarifier feed, RotaCut can be installed with your existing pumping equipment, or as a package with a

Vogelsang positive displacement pump. Additional uses are specific solids conditioning for maximum effectiveness of heat exchangers and SBR plants. Stop ragging and hair build-up for good.



Industrial & Chemical Facilities

Macerating solids such as rags, paper, wood, and sand, and separating out solids like nuts and bolts, RotaCut protects downstream pumps and equipment. Fuel recycling plants, truck on and off loading,

chemical container disposal, soil remediation facilities, and oilspill clean-up are applications that require specific size conditioning of solids, to provide maximum performance of downstream equipment.



Food Industry

Used either pre-process or post-process, the RotaCut in-line is your answer to solids conditioning in many food related applications. From processing potato, fruit, and vegetable waste into mash, to reduction of solids of animal internals, RotaCut provides a cost-

effective way of making common scrap material into revenue generation through saleable conditioned feed stock for Bio-Gas and similar energy producing processes, in addition to animal feed enrichment stock.



Pulp & Paper

Protecting mainly the wastewater side of the process, RotaCut in-line macerators, protect the clarifiers, primary and secondary sludge pumps, belt filter and plate and frame presses, and centrifugal pumps from

wood chips and bark, wire, coarse debris, floor drain waste, rags, rope, string, and other fibrous material, that could easily damage typical processing equipment.



Agricultural Applications

Either mounted on a three point hitch, or directly to the side of a tanker or tractor. The RotaCut hydraulically driven units provide a compact foot print with a punch. Pre-macerating lagoon solids prior to land application reduces down-time associated with

distribution head blockage, and further enriches the nutrients applied to the field, through ease of equal distribution of solids. Ear tags, hoof trimmings, bailing wire, stones and rocks, are ground to a manageable size, for easy application.



General Scrap Waste Processing

Used in a multitude of applications, RotaCut macerates textile and woven waste, plastic and wood waste, rubber and re-macerate waste, fiberglass insulation, and related fiberglass products, tannery and leather goods, cardboard and similar packaging waste, and

a multitude of wood by-products. Used in power plants, cogeneration, nuclear installations, automotive, electrical, and apparel plants, RotaCut provides uninterrupted service to the markets of the world.



Worldwide Factory & Sales Office Locations:

The Americas:

Factory:

Vogelsang USA
7966 State Route 44
PO Box 751
Ravenna, Ohio 44266

Toll-Free: 800.984.9400
Tel: 330.296.3820
Fax: 330.296.4113

sales@vogelsangusa.com
www.vogelsangusa.com

Germany:

Factory:

Vogelsang Maschinenbau GmbH
Holthöge 10-14
D-49632 Essen Oldb.

Tel: +49.5434.830
Fax: +49.5434.8310

info@vogelsang-gmbh.com
www.vogelsang-gmbh.com

Vogelsang Maschinenbau GmbH
Lindenweg 7
D-06295 Rothenschirmbach

Tel: +49.34776.20581
Fax: +49.34776.20582

rsb@vogelsang-gmbh.com
www.vogelsang-gmbh.com

Denmark:

Vogelsang A/S
Smedesvinget 6
DK-6880 Tarm

Tel: +45.9737.2777
Fax: +45.9737.3077

vogelsang@adr.dk
www.vogelsang-gmbh.com

Hungary:

Vogelsang
10 Raho Street
Budapest H-1118

Tel: +36.1319.2551
Fax: +36.1319.2553

edes@vogelsang-gmbh.com
www.vogelsang-gmbh.com

United Kingdom & Eire:

Vogelsang UK
Unit 13 Cobden Ind. Est.
Quakers Coppice
Crewe Gates
Crewe, Cheshire, CW1 6EW

Tel: +44.1270.216600
Fax: +44.1270.216699

sales@vogelsang.co.uk
www.vogelsang.co.uk

Asia:

Vogelsang Malaysia
24 Jalan Ara SD7/3D
Bandar Sri Damansara
52200 Kuala Lumpur

Tel. & Fax: +60.362.729187

chan@vogelsang-gmbh.com
www.vogelsang-gmbh.com

France:

Vogelsang S.a.r.l.
Zone Artisanale de Fontgrave
in 26740 Montboucher Sur
Jabron

Tel: +33.673.61.58.64

giordan@vogelsang-gmbh.com
www.vogelsang-gmbh.com

**Contact your authorized distributor or call
800.984.9400 for more information.**

Your authorized Vogelsang dealer:

