

Process Industrial Pumps



7071 Series **ANSI Standard Dimension**



**RUTHMAN
COMPANIES**



7071 Series

Process Industrial Pumps

- Capacities to 6000 GPM
- Heads to 750 feet
- Temperatures to 500° F (250° C)
- Pressures to 300 PSIG



Performance Features For General Service

Pump Reliability

- Heavy Duty Construction
- Foot-mounted Casing
- Center Line Intake and Discharge

Ease of Maintenance

- Back Pull-out Design
- Maximum Interchangeability
- Cartridge Seals Available

Simple Installation

- ANSI 16.5 Standard Flanges
- ANSI 73.1 Style Casing

For process industrial services, the 7071 Series is a perfect reliable and economical solution.

The 7071 Series is also easy to operate and maintain with the added benefit of substantially reduced maintenance costs.

Services

Food Processing	Liquid Transfer
Chemical	Pulp and Paper
Oil	Pharmaceutical
Textile	Paint Systems
Filtration	and many more...

Custom Design

- Design and Manufacture to your Application Needs

ANSI Standard Dimension



7071 Series Options

Finned Cooler

For high temperature applications.

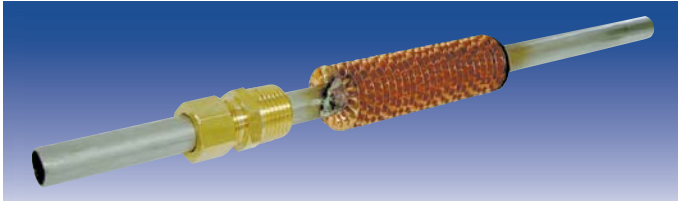

Jacketed Stuffing Box

For high temperature applications. Back pull-out design for ease of maintenance.

Standard Bore Stuffing Box

Accommodates many of today's seal sizes and styles such as cartridges, component and packing.



Base Plates

Gusher has a variety of base plates for your specific requirements.



Cast Iron

Fabricated Steel



Base plates are also supplied with jack bolts to aid in alignment.

Repeller

When seals are not effective, Gusher provides repeller style sealing for abrasive applications.

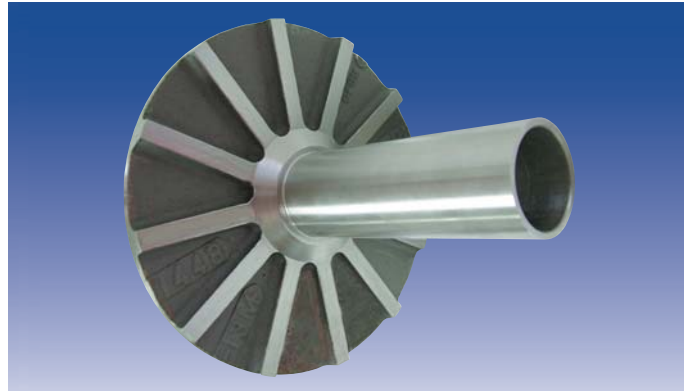

Safety – Coupling Guards

Gusher provides guards around rotating parts to meet plant safety requirements.



In-Line Adapter

Convert your center line closed coupled pump to an in line.



ANSI B-73.1 Design Features

Gusher 7071 Series ANSI Standard Dimension Process Pumps

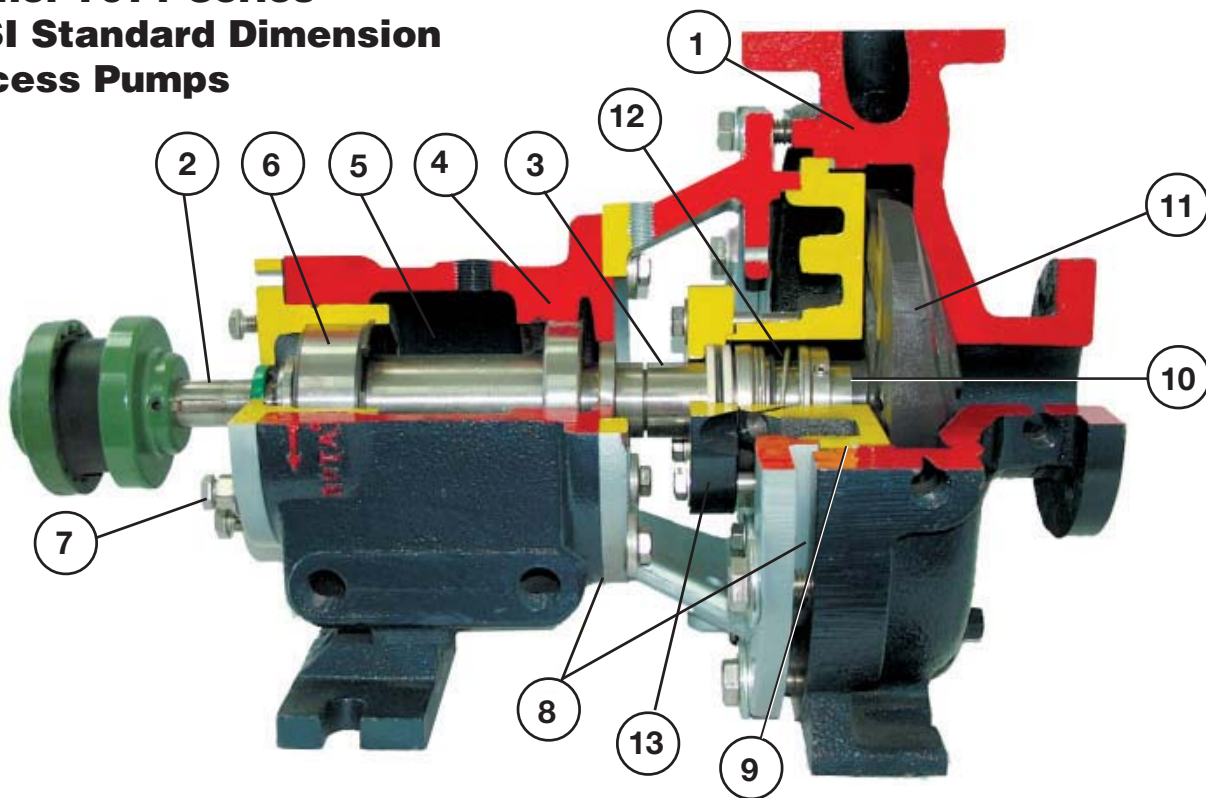

Design Features:

- 1. Heavy Duty Casings**—increases life under corrosive and erosive conditions. All sizes are self venting with CL discharge. Drain plug offered as option.
- 2. Heavy Duty Shaft**—Minimum deflection increases life for less maintenance.
- 3. Renewable Shaft Sleeve**—Hook-type sleeve eases maintenance (easily removed) and is relieved to allow for changes in temperature.
- 4. Power Frame**—Heavy duty Power Frame is sealed against contaminants to ensure long bearing life. Water-cooled for high temperature applications.
- 5. Oil Lubrication**—Oil lubrication is standard. The power frame is vented. Oil may also be cooled for high temperature application.
- 6. Heavy Duty Thrust Bearing**—Double row thrust bearing minimizes shaft end play for more effective stuffing box sealing, longer mechanical seal life and withstands greater axial and radial thrust loads.
- 7. External Impeller Adjustment**—Like new clearance can be maintained through simple external adjustment in just minutes to maintain original high efficiencies.
- 8. Rabbeted Fits**—Accurately machined rabbets ensure positive alignment, longer seal life, easy replacement of spare rotating when maintenance is required.
- 9. Contained Casing Gasket**—Protects against blow out.
- 10. Positive Sealing at Impeller**—Teflon O-Ring protects shaft from liquid being pumped.
- 11. Semi Open Impeller**—is designed with back pump-out vane to minimize axial thrust. Designed to handle solids and stringy material.*
- 12. Mechanical Seal**
- 13. Seal Gland**

*The 3x4-16 and the 5x6-16 have enclosed impellers.

Dimensional Interchangeability

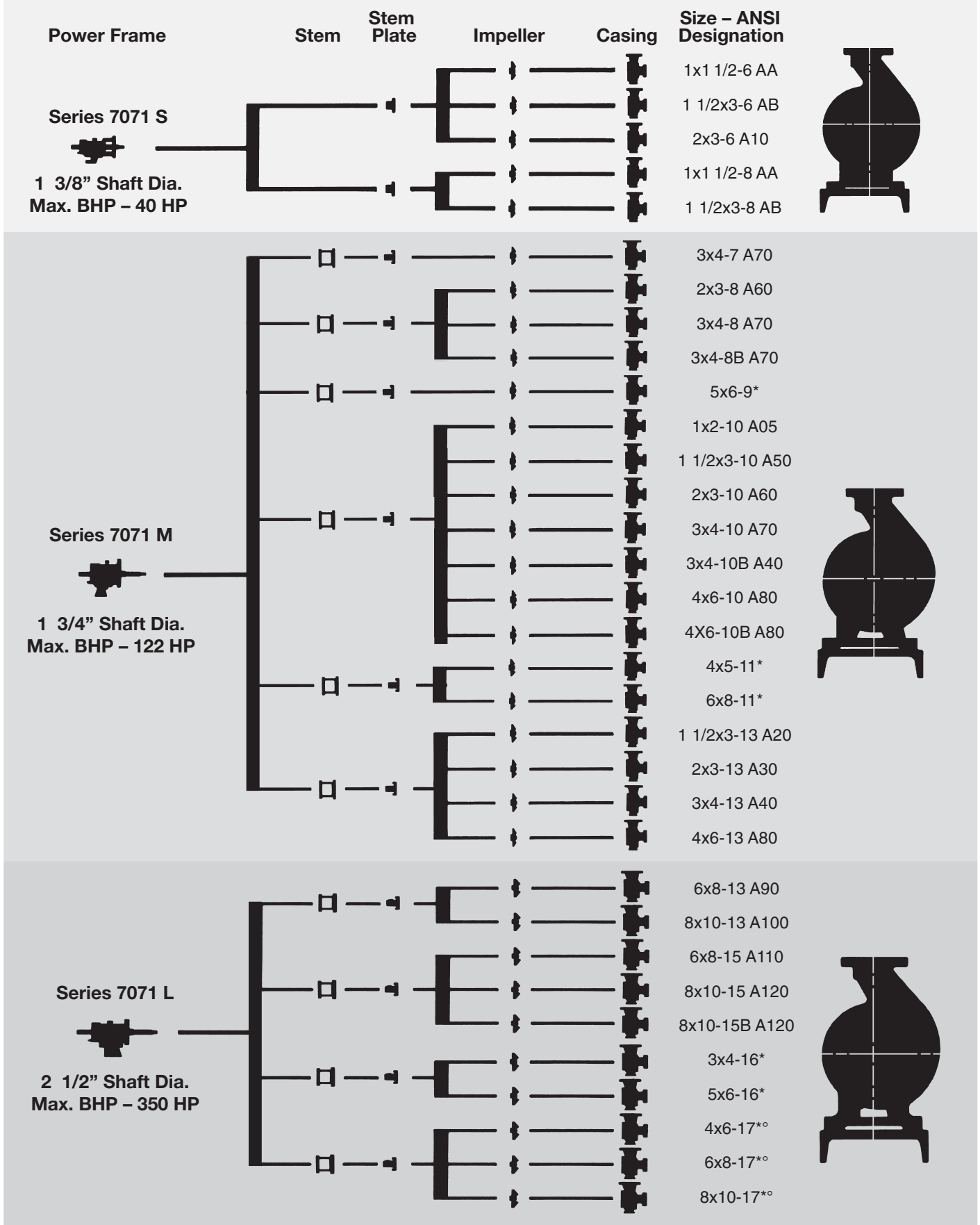

*No ANSI designation Available °7071 XL

7071S Series W/67220 Base

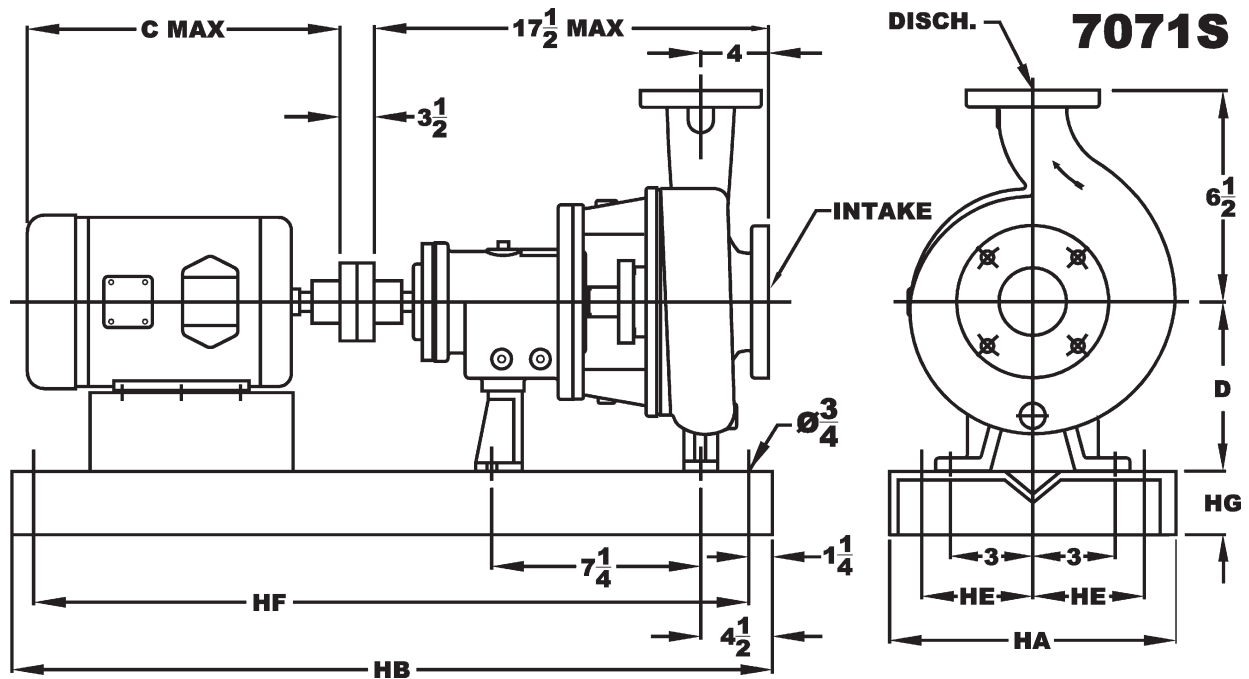

Model	Discharge	Intake	Shaft Dia.	Keyway	Weight
1x1 1/2-6	1	1 1/2	7/8	3/16x3/32	85
1 1/2x3-6	1 1/2	3	7/8	3/16x3/32	95
2x3-6	2	3	7/8	3/16x3/32	98
1x1 1/2-8	1	1 1/2	7/8	3/16x3/32	105
1 1/2x3-8	1 1/2	3	7/8	3/16x3/32	110

NEMA Frm.	Baseplate	C(MAX.)	D	HA	HB	HE	HF	HG
56-145	1S	13 1/2	5 1/4	10	35	4	32 1/2	3
182-215	2S	19 1/2	5 1/4	12	39	4 1/2	36 1/2	3 1/4
254-286	3S	27	6 1/4	15	46	6	43 1/2	4 1/8

7071M Series W/67220 Base

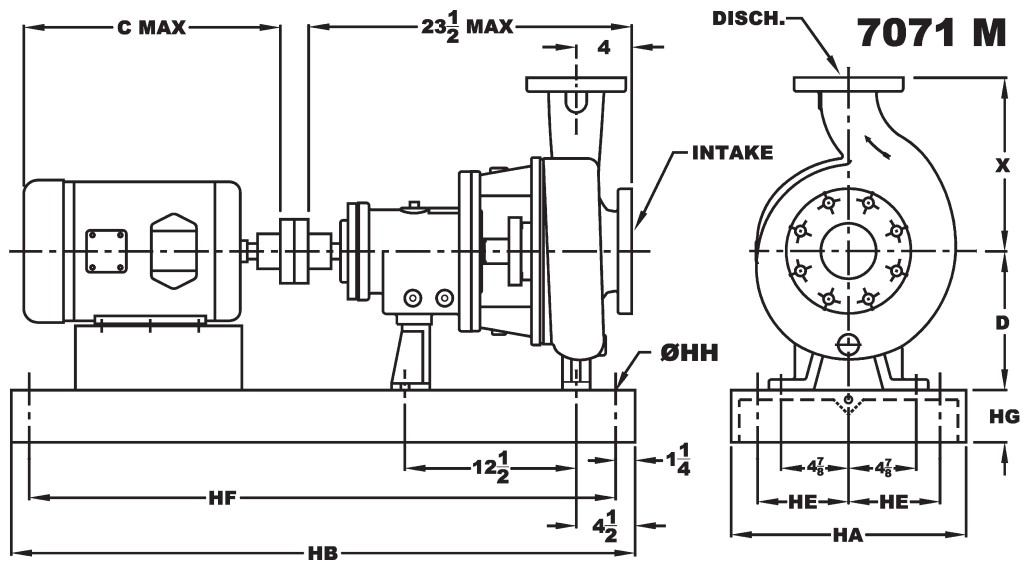

Model	Discharge	Intake	X	D	Shaft Dia.	Keyway	Weight
3x4-7	3	4	11	8 1/4	1 1/8	1/4x1/8	225
2x3-8	2	3	9 1/2	8 1/4	1 1/8	1/4x1/8	205
3x4-8	3	4	11	8 1/4	1 1/8	1/4x1/8	225
3x4-8B	3	4	11	8 1/4	1 1/8	1/4x1/8	225
5x6-9*	5	6**	13 1/2	10	1 1/8	1/4x1/8	325
1x2-10	1	2	8 1/2	8 1/4	1 1/8	1/4x1/8	205
1 1/2x3-10	1 1/2	3	8 1/2	8 1/4	1 1/8	1/4x1/8	225
2x3-10	2	3	9 1/2	8 1/4	1 1/8	1/4x1/8	235
3x4-10	3	4	11	8 1/4	1 1/8	1/4x1/8	270
3x4-10B	3	4	12 1/2	10	1 1/8	1/4x1/8	280
4x6-10	4	6**	13 1/2	10	1 1/8	1/4x1/8	310
4X6-10B	4	6	13 1/2	10	1 1/8	1/4x1/8	310
4x5-11*	4	5**	13 1/2	10	1 1/8	1/4x1/8	325
6x8-11*	6	8	16	14 1/2	1 1/8	1/4x1/8	475
1 1/2x3-13	1 1/2	3	10 1/2	10	1 1/8	1/4x1/8	250
2x3-13	2	3	11 1/2	10	1 1/8	1/4x1/8	280
3x4-13	3	4	12 1/2	10	1 1/8	1/4x1/8	335
4x6-13	4	6**	13 1/2	10	1 1/8	1/4x1/8	410

NEMA Frm.	Baseplate	C	HA	HB	HE	HF	HG	HH
143-215	1M	19 1/2	12	45	4 1/2	42 1/2	3 3/4	3/4
254-286	2M	27	15	52	6	49 1/2	4 1/8	1
324-326	3M	30	18	58	7 1/2	55 1/2	4 3/4	1
364-365	3M	34	18	58	7 1/2	55 1/2	5 3/4 ¹ -4 3/4 ²	1
404-405	4M	35 1/2	22	60	7 1/2	57 1/2	6 3/4 ¹ -5 ²	1
44	4M	46 1/2	22	60	7 1/2	57 1/2	7 3/4 ¹ -6 ²	1

¹Pump with 8 1/4" D Dimension ²Pump with 10" Dimension ** Suction Flange has 8 .75-1 UNC tapped holes * No ANSI designation Available

7071L Series W/67220 Base

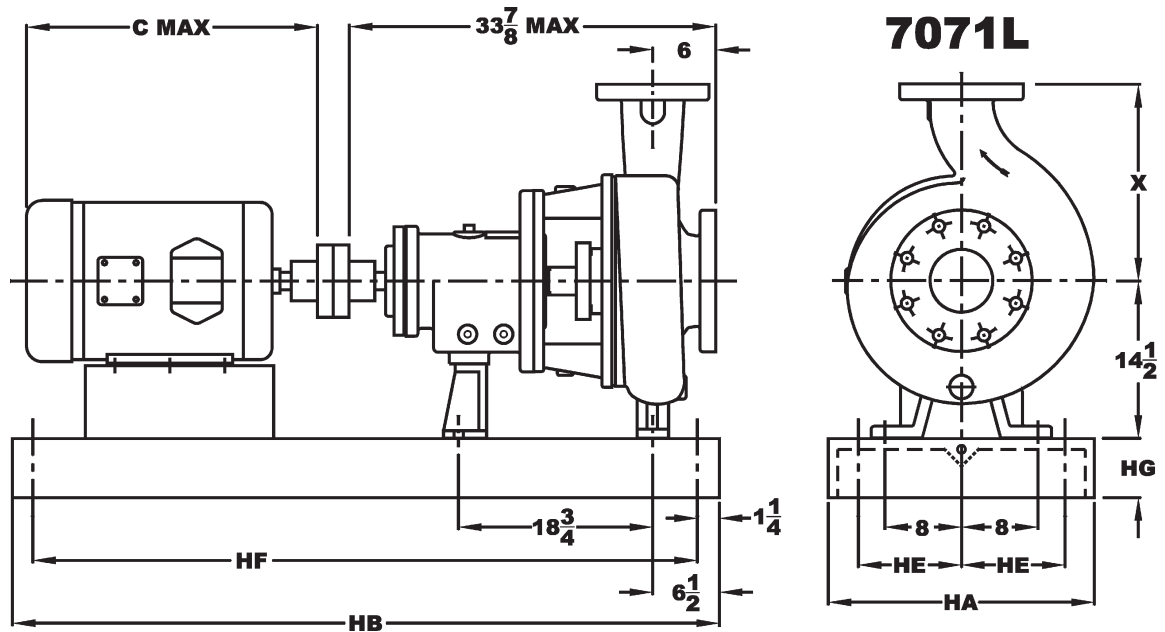

Model	Discharge	Intake	X	Shaft Dia.	Keyway	Weight
6x8-13	6	8	16	2 3/8	5/8x5/16	565
8x10-13	8	10	18	2 3/8	5/8x5/16	575
6x8-15	6	8	18	2 3/8	5/8x5/16	616
8x10-15	8	10	19	2 3/8	5/8x5/16	750
8x10-15B	8	10	19	2 3/8	5/8x5/16	720
4x6-17*°	4	6	16	2 3/8	5/8x5/16	650
6x8-17*°	6	8	18	2 3/8	5/8x5/16	730
8x10-17*°	8	10	19	2 3/8	5/8x5/16	830

NEMA Frm.	Baseplate	C	HA	HB	HE	HF	HG
213-256	1L	24	22	62	9 1/2	59 1/2	4
284-365	2L	34	22	68	9 1/2	65 1/2	4 3/4
404-445	3L	46 1/2	22	80	9 1/2	77 1/2	4 3/4
447	4L	46 1/2	26	90	9 1/2	87 1/2	4

7071L Series W/67220 Base

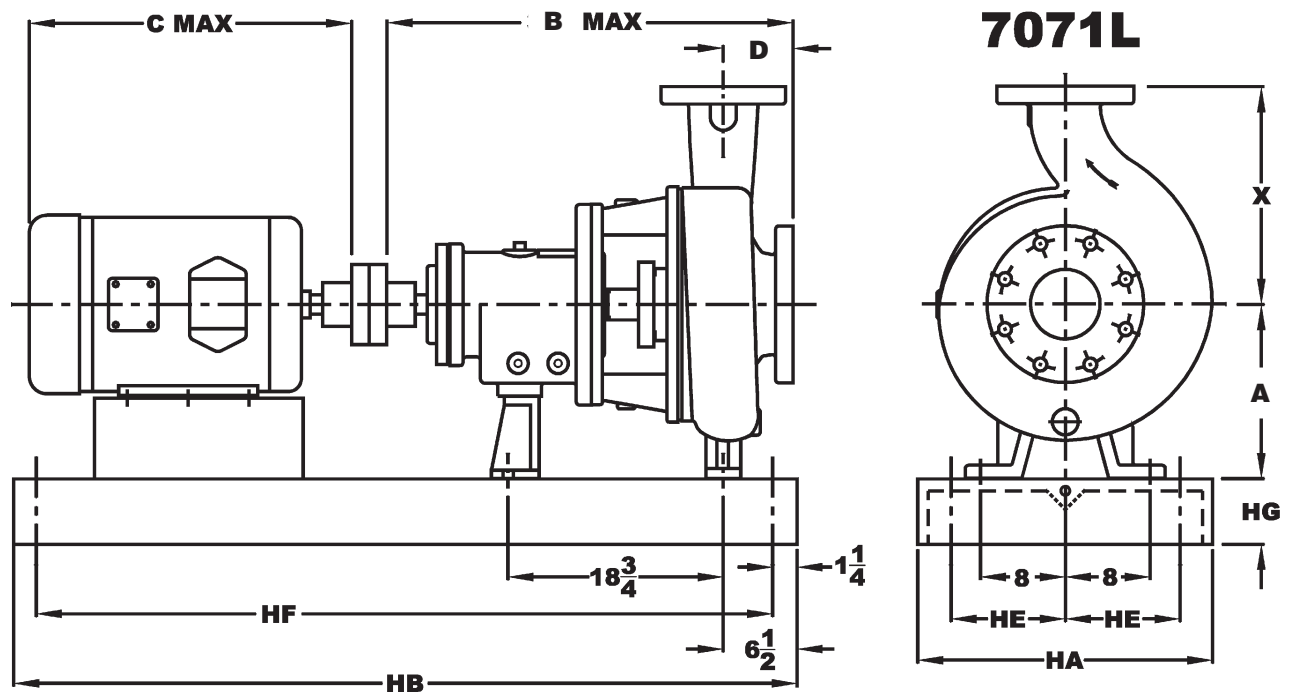

Model	Discharge	Intake	X	A	B	D	Shaft Dia.	Keyway	Weight
3x4-16E*	3	4	14	11	33	4 7/8	2 3/8	5/8x5/16	675
5x6-16E*	5	6	15 3/4	12 3/8	33	5 3/4	2 3/8	5/8x5/16	700

NEMA Frm.	Baseplate	C	HA	HB	HE	HF	HG
213-256	1L	24	22	62	9 1/2	59 1/2	4
284-365	2L	34	22	68	9 1/2	65 1/2	4 3/4
404-445	3L	46 1/2	22	80	9 1/2	77 1/2	4 3/4
447	4L	46 1/2	26	90	9 1/2	87 1/2	4

*No ANSI designation Available

Pump Selection Curves

7071 CL 1x1.5-6SE 1765 rpm

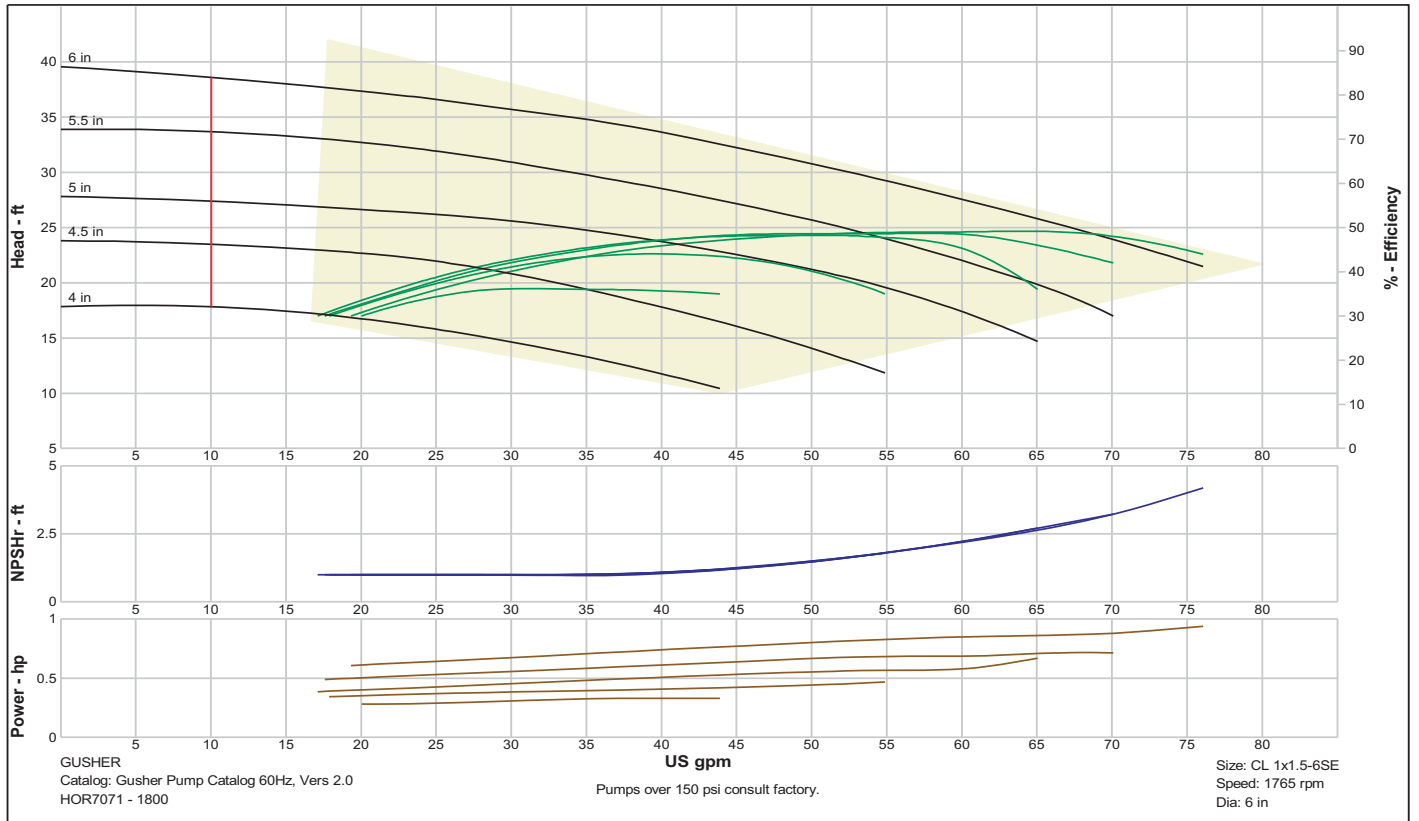

7071 CL 1x1.5-6SE 3480 rpm

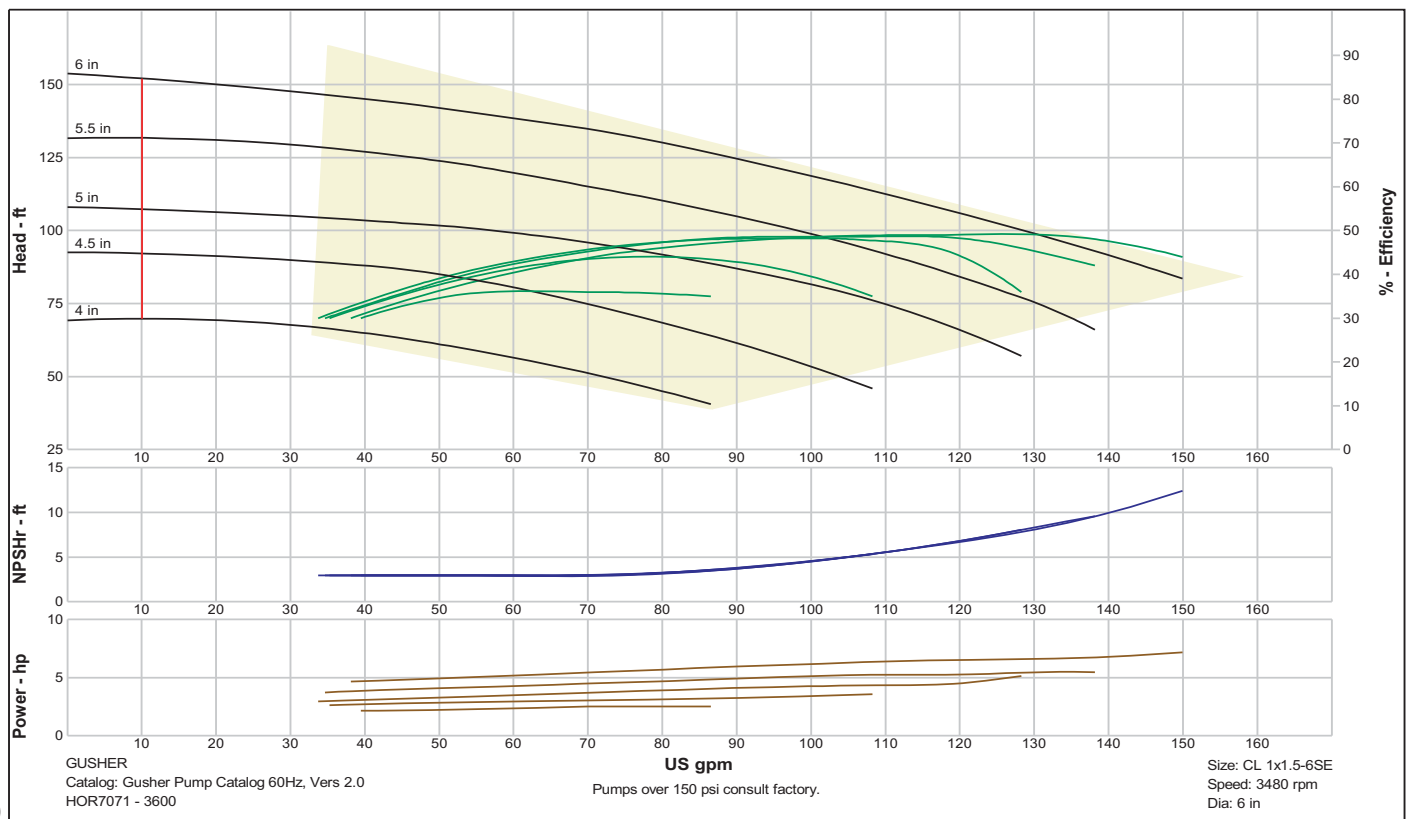

Pump Selection Curves

7071 CL 1.5x3-6SE 1765 rpm

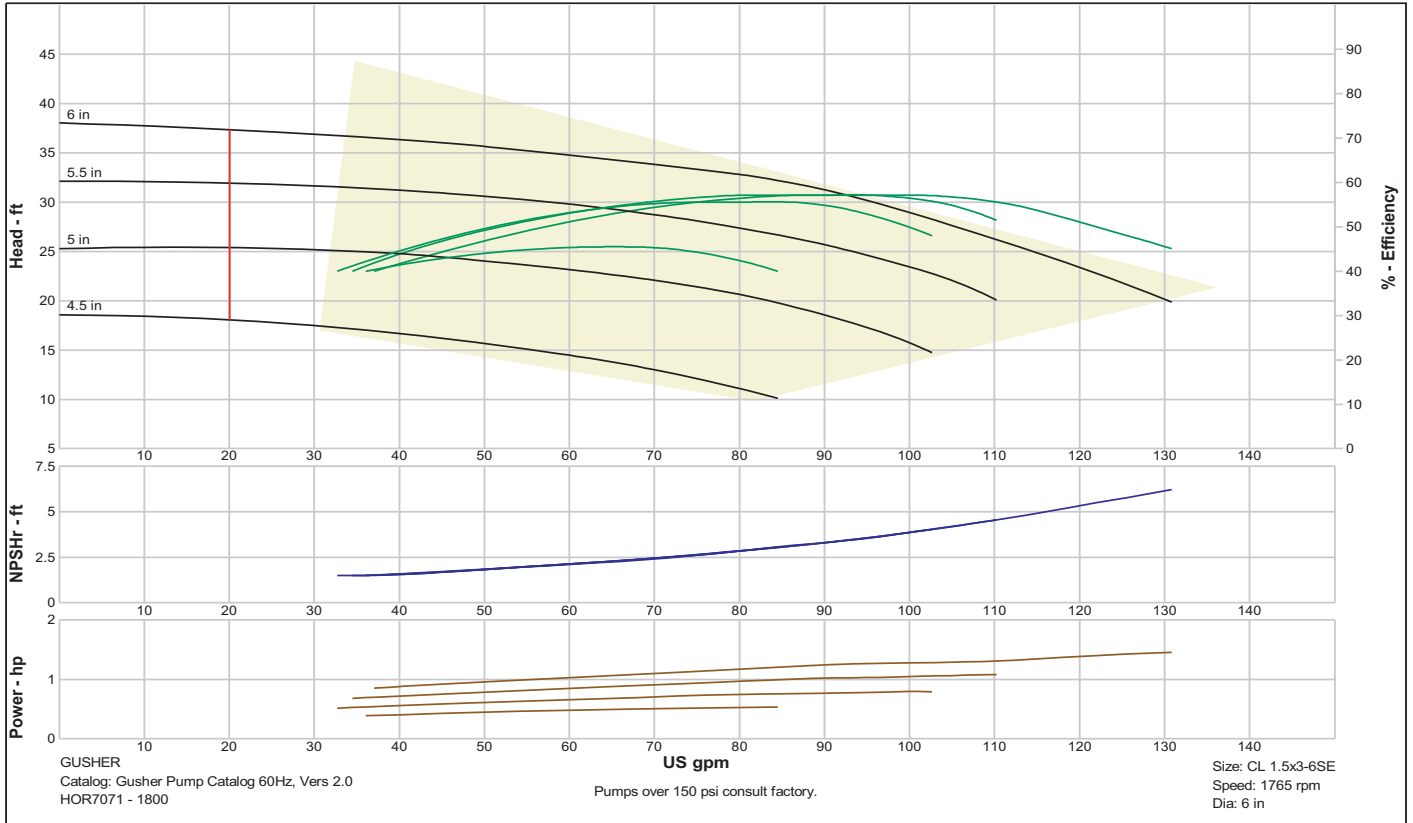

7071 CL 1.5x3-6SE 3480 rpm

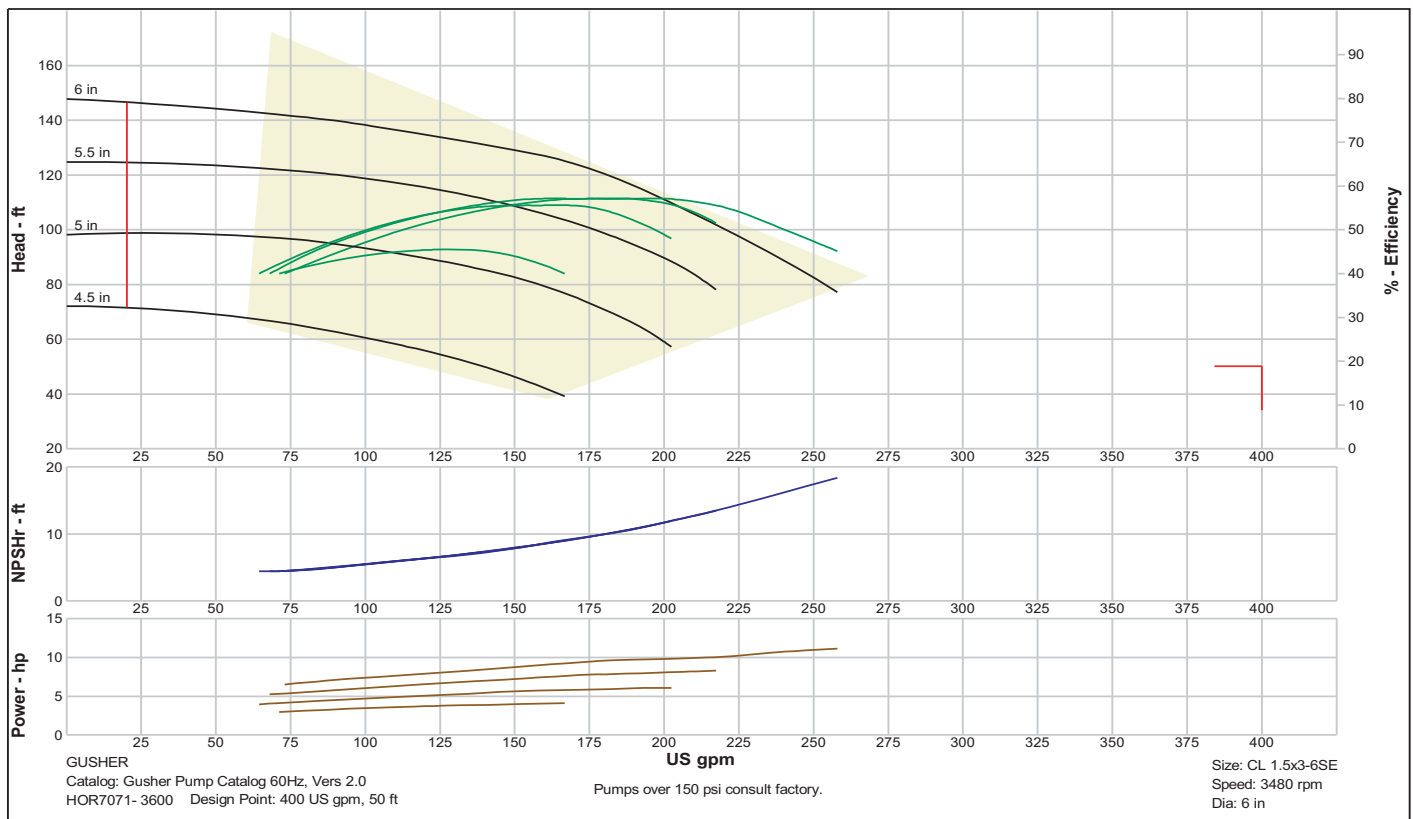

Pump Selection Curves

7071S CL 2x3-6SE 1765 rpm

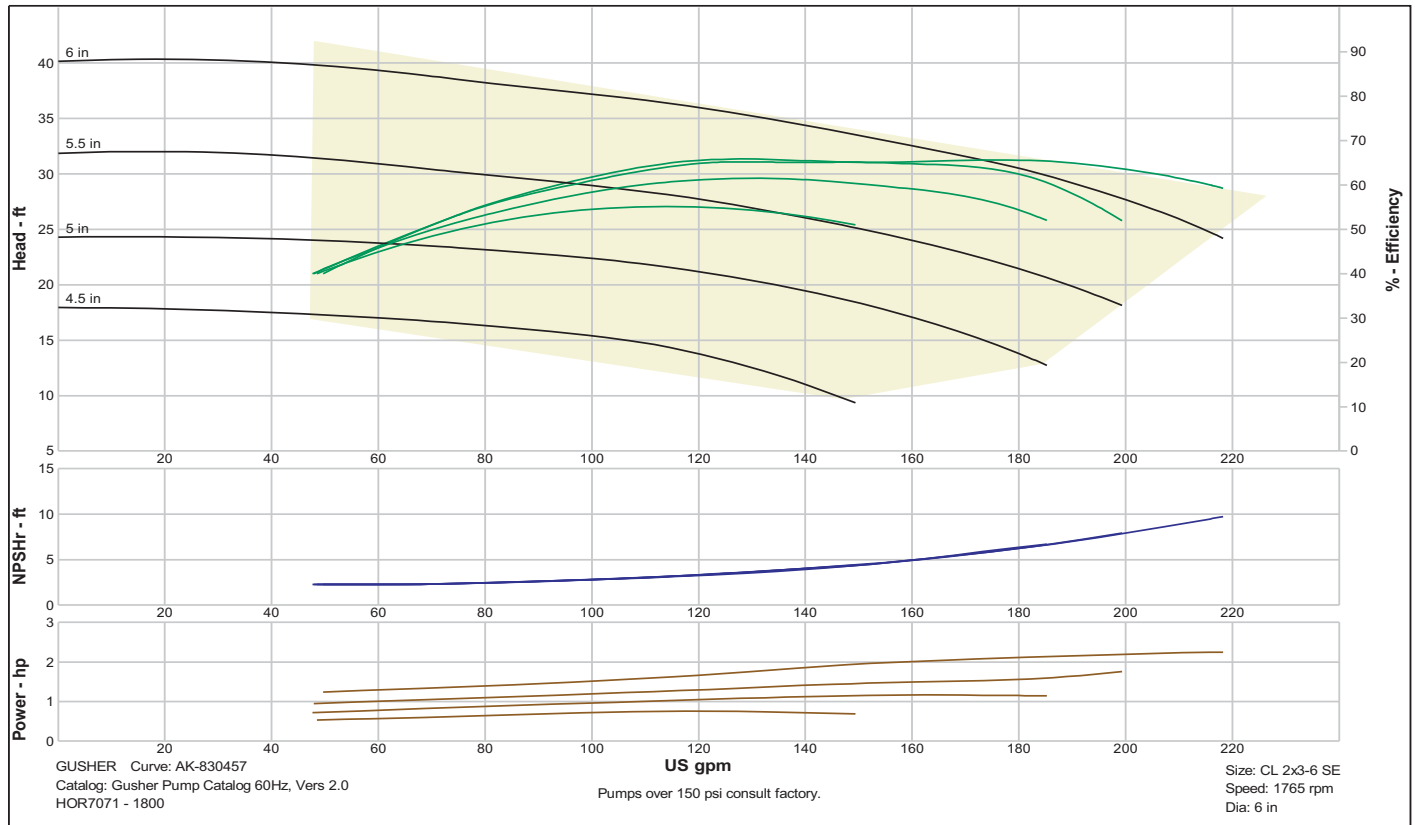

7071S CL 2x3-6SE 3480 rpm

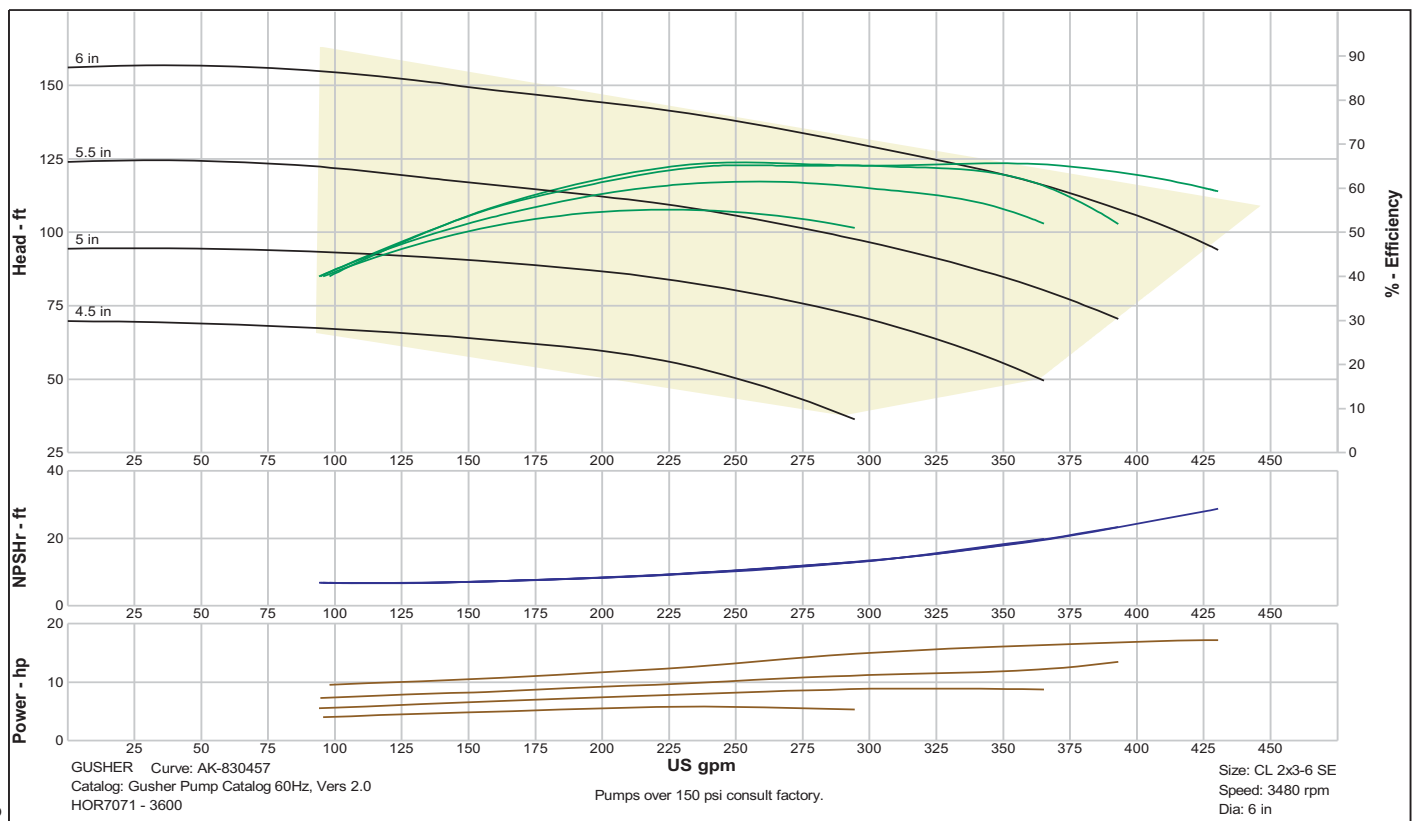

Pump Selection Curves

7071S CL 1x1.5-8SE 1765 rpm

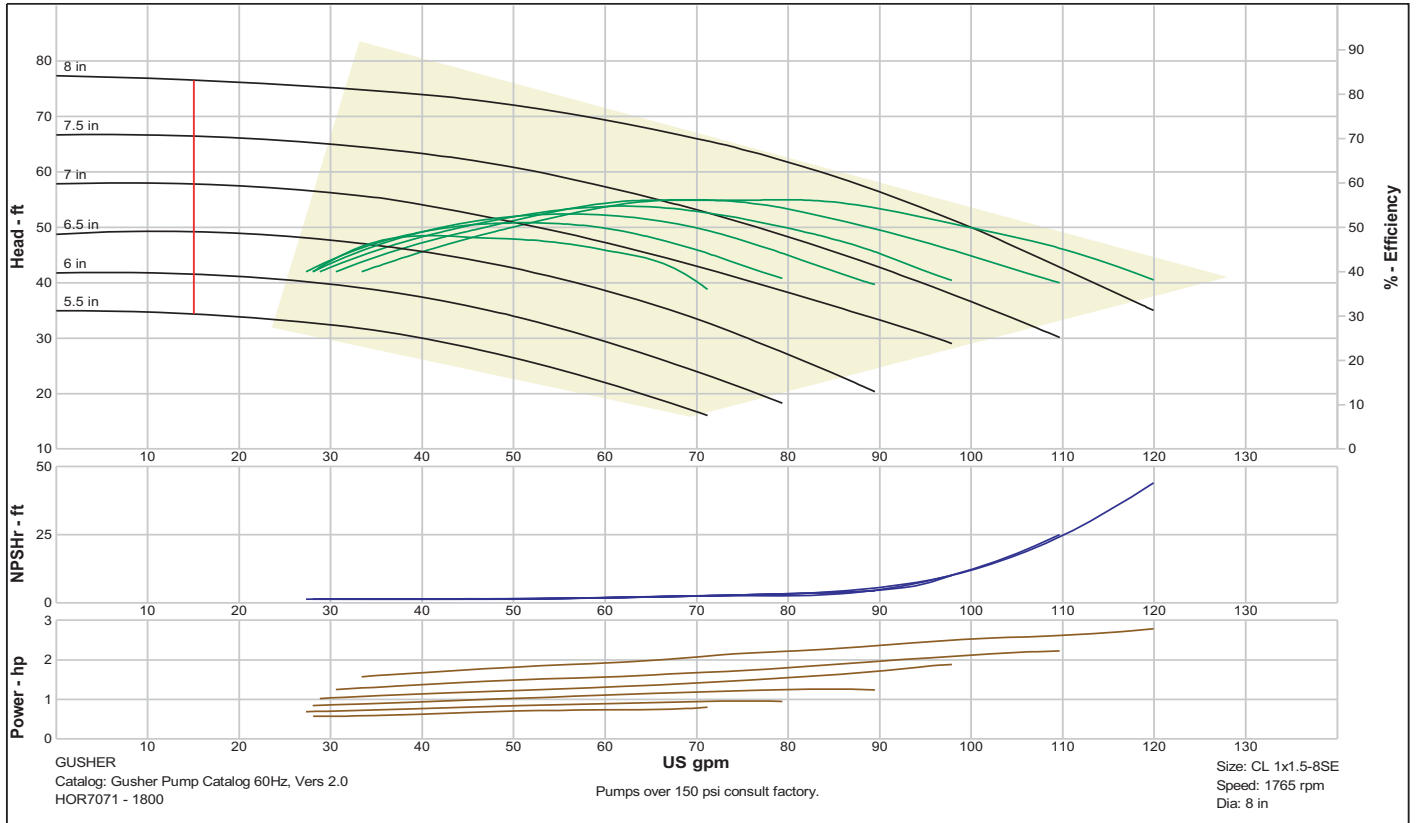

7071S CL 1x1.5-8SE 3480 rpm

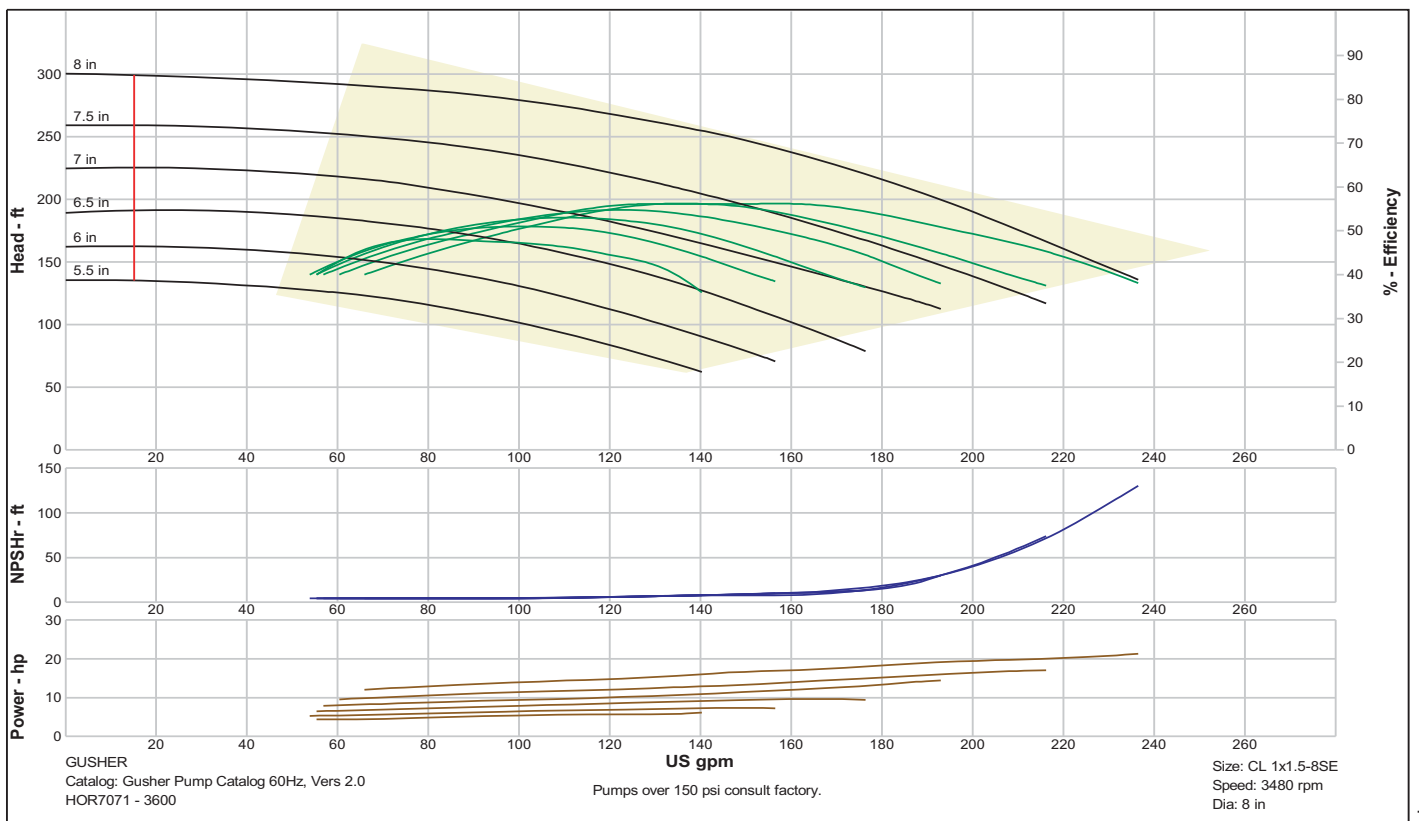

Pump Selection Curves

7071S CL 1.5x3-8SE 1765rpm

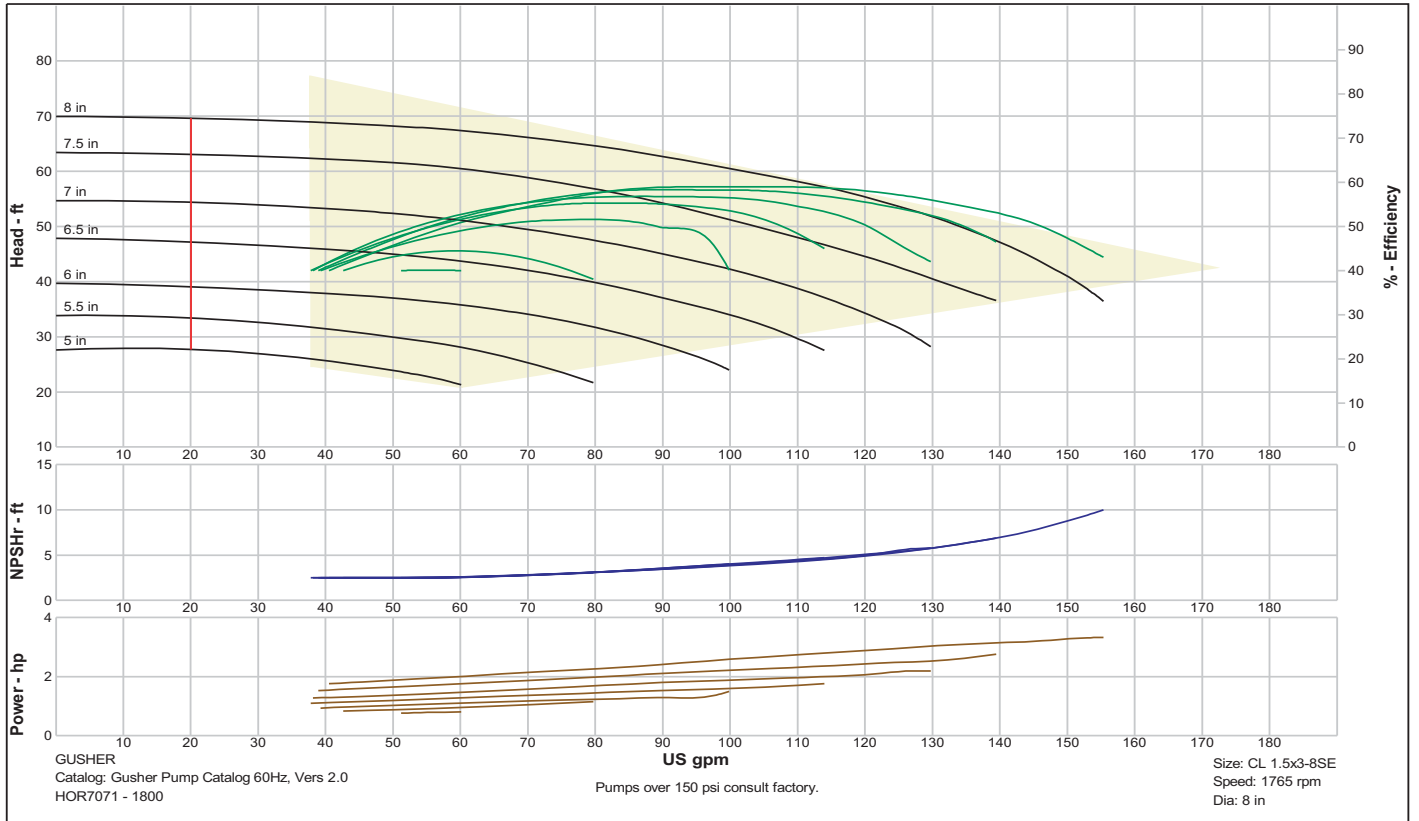

7071S CL 1.5x3-8SE 3480 rpm

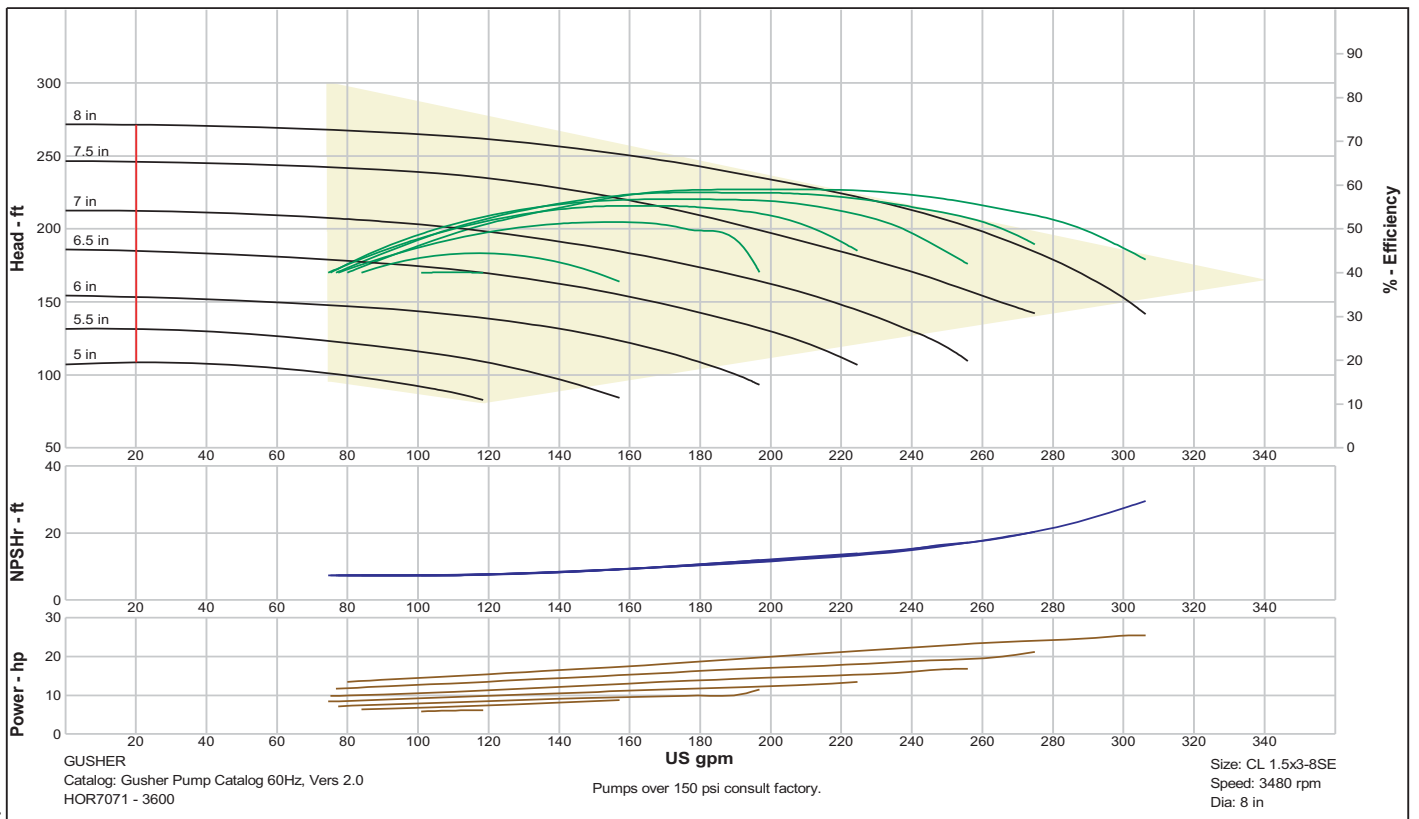

Pump Selection Curves

7071M CL 3x4-7SE 1765 rpm

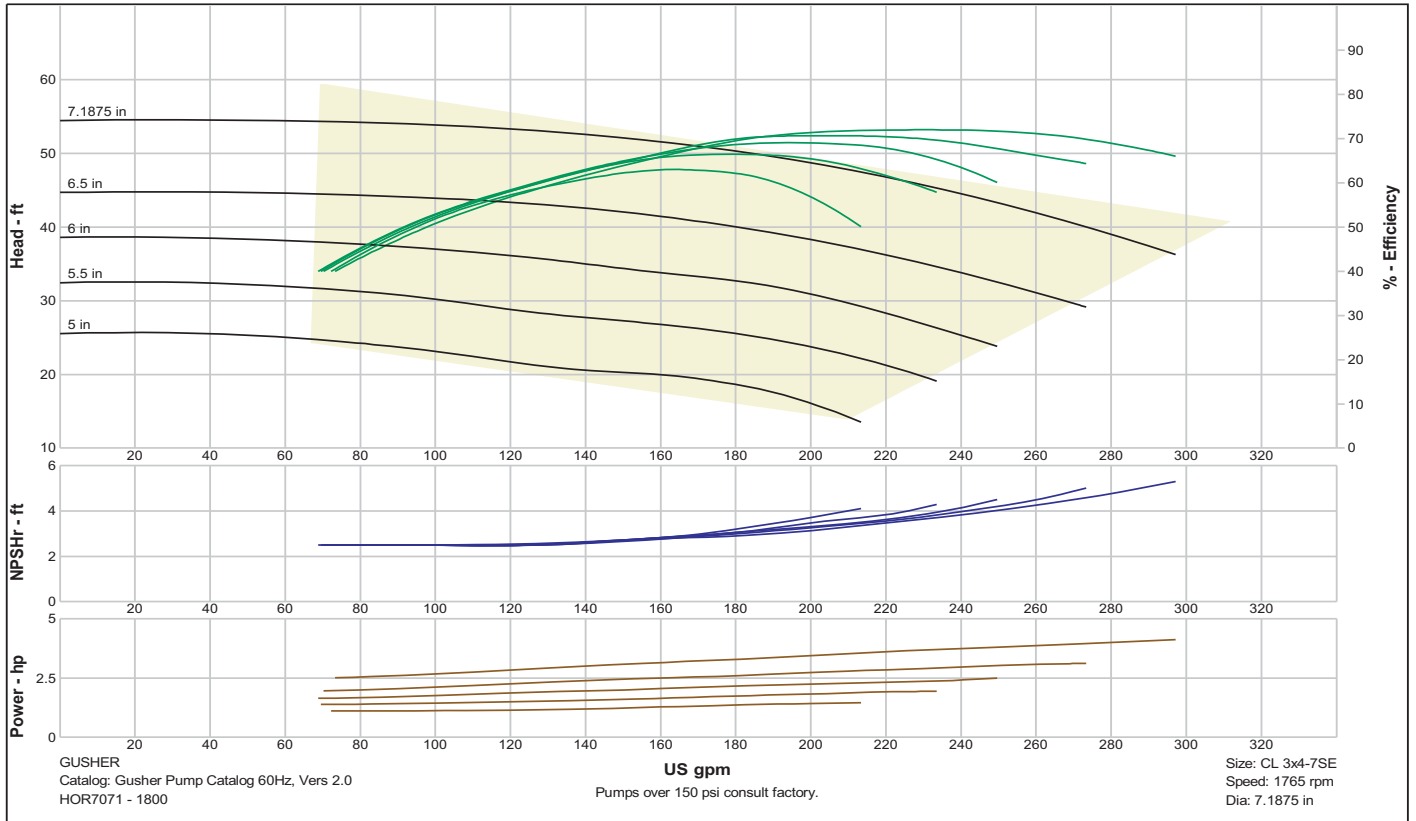

7071M CL 2x3-8SE 1765 rpm

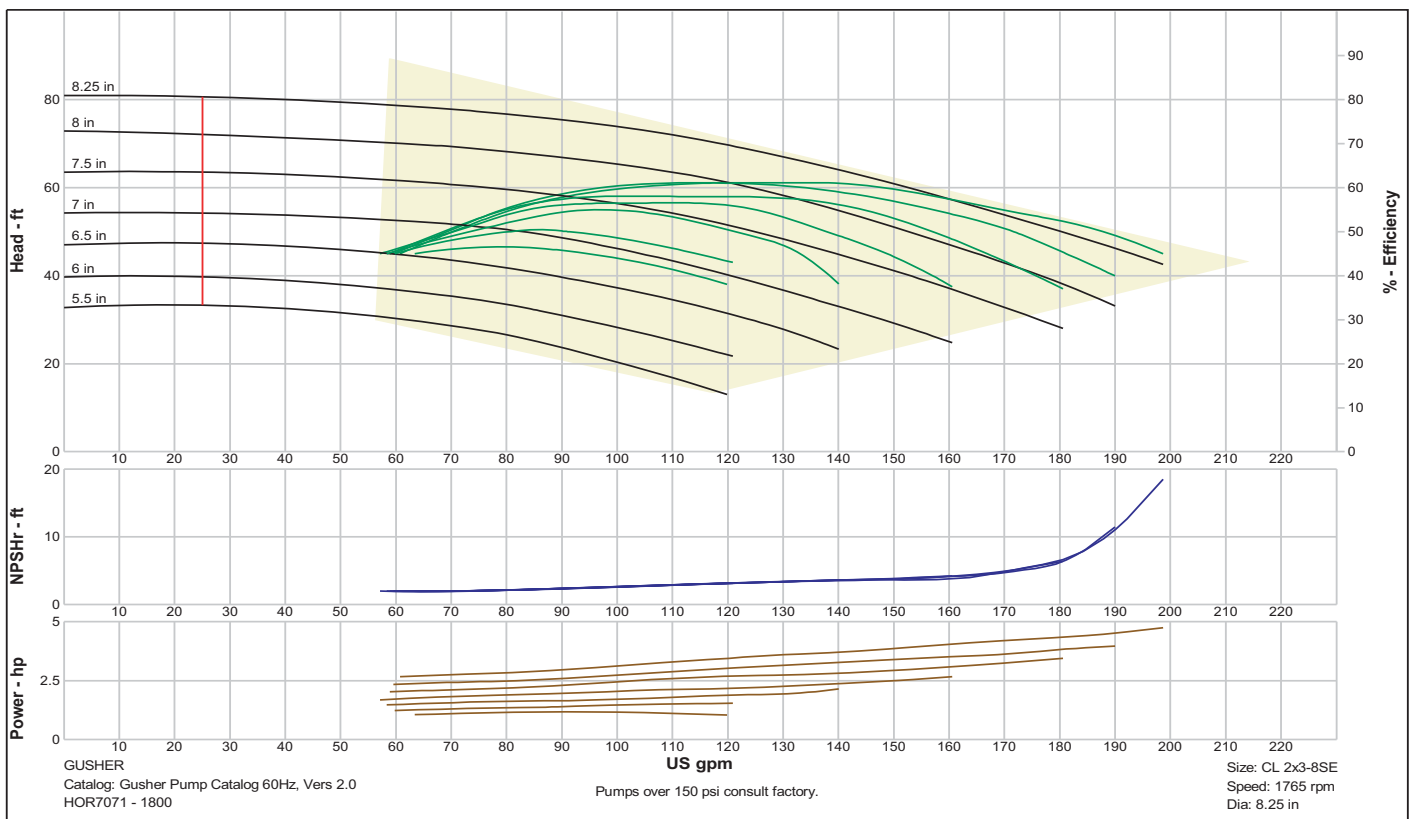

Pump Selection Curves

7071M CL 2x3-8SE 3480 rpm

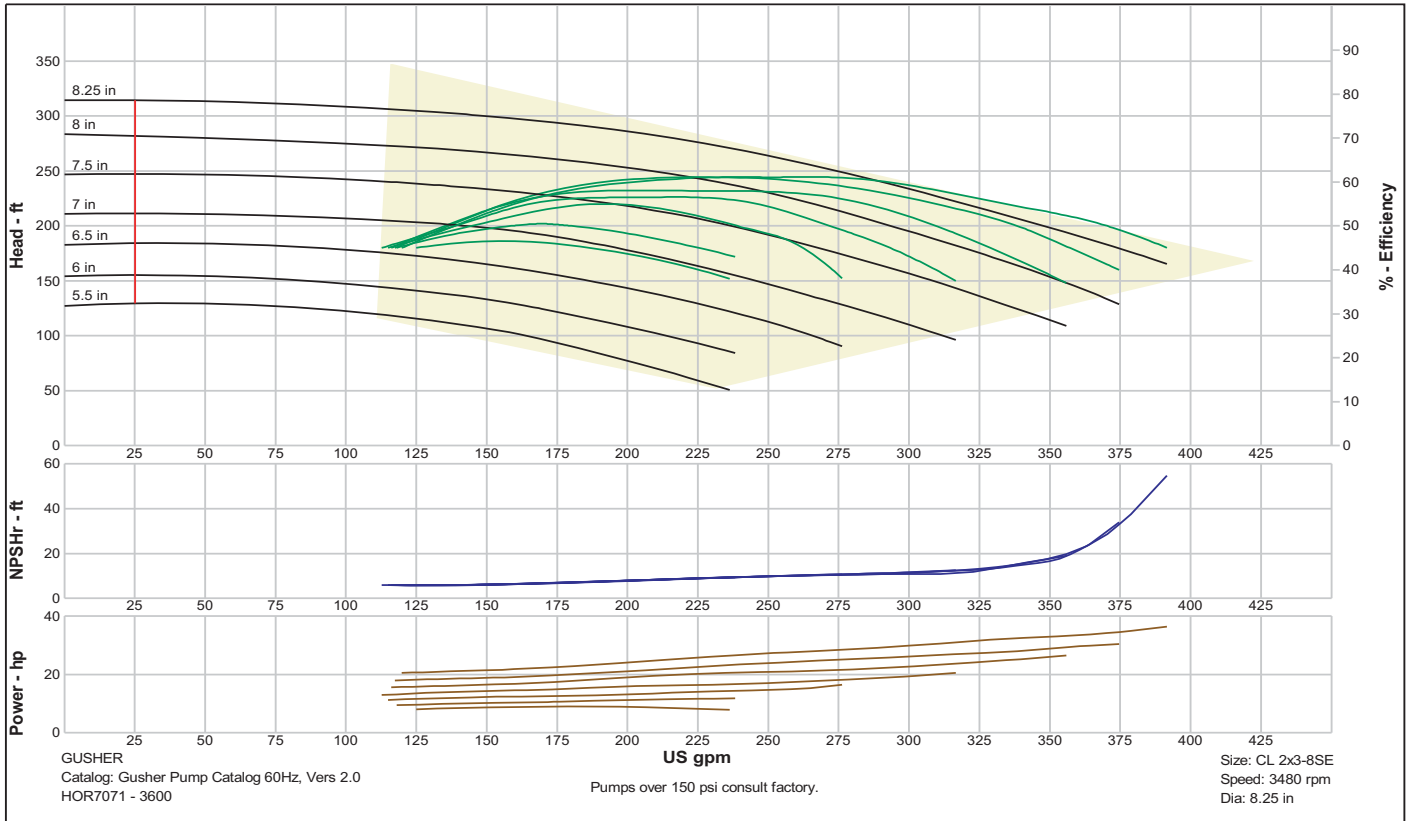

7071M CL 3x4-8SE 1765 rpm

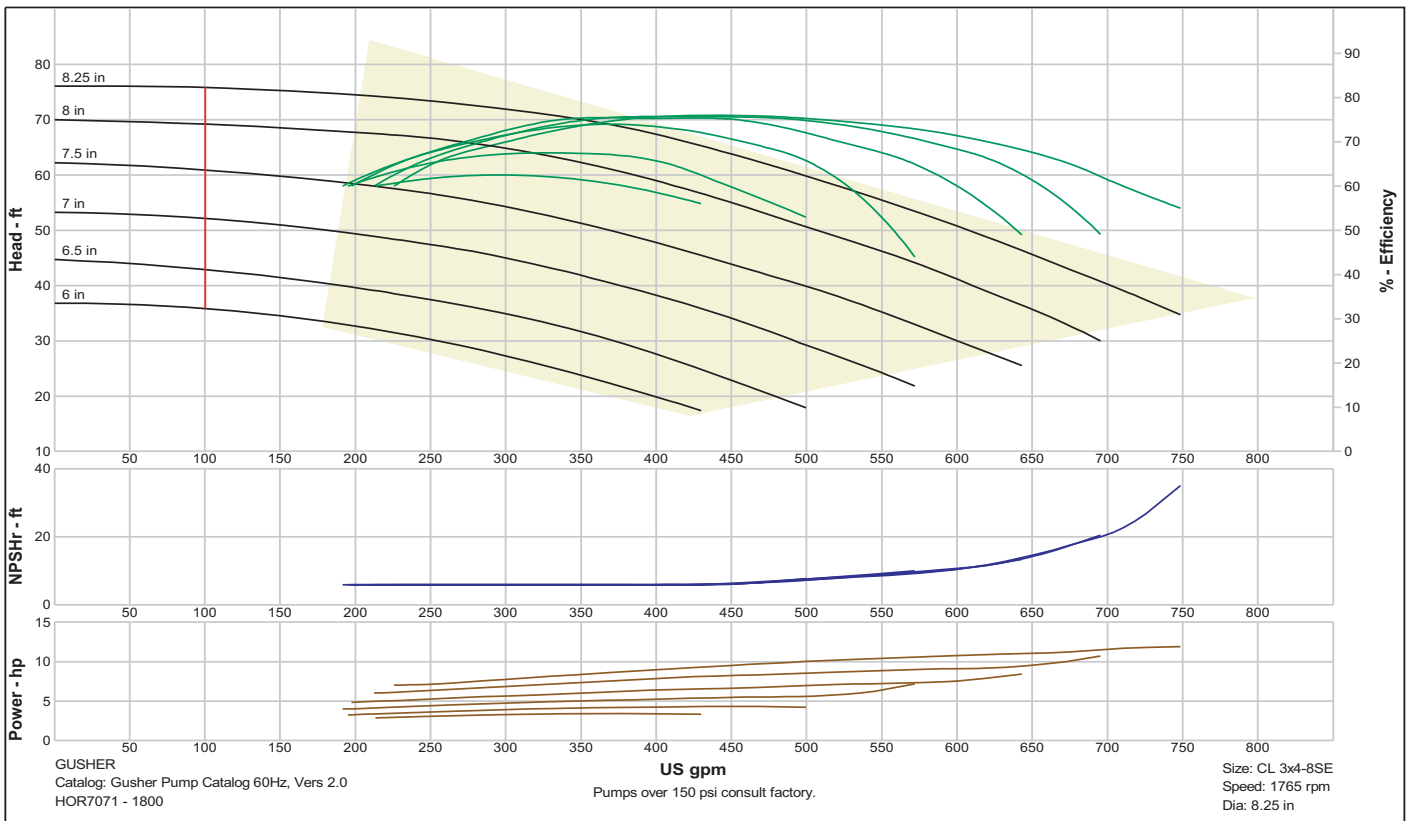

Pump Selection Curves

7071M CL 3x4-8BSE 1765 rpm

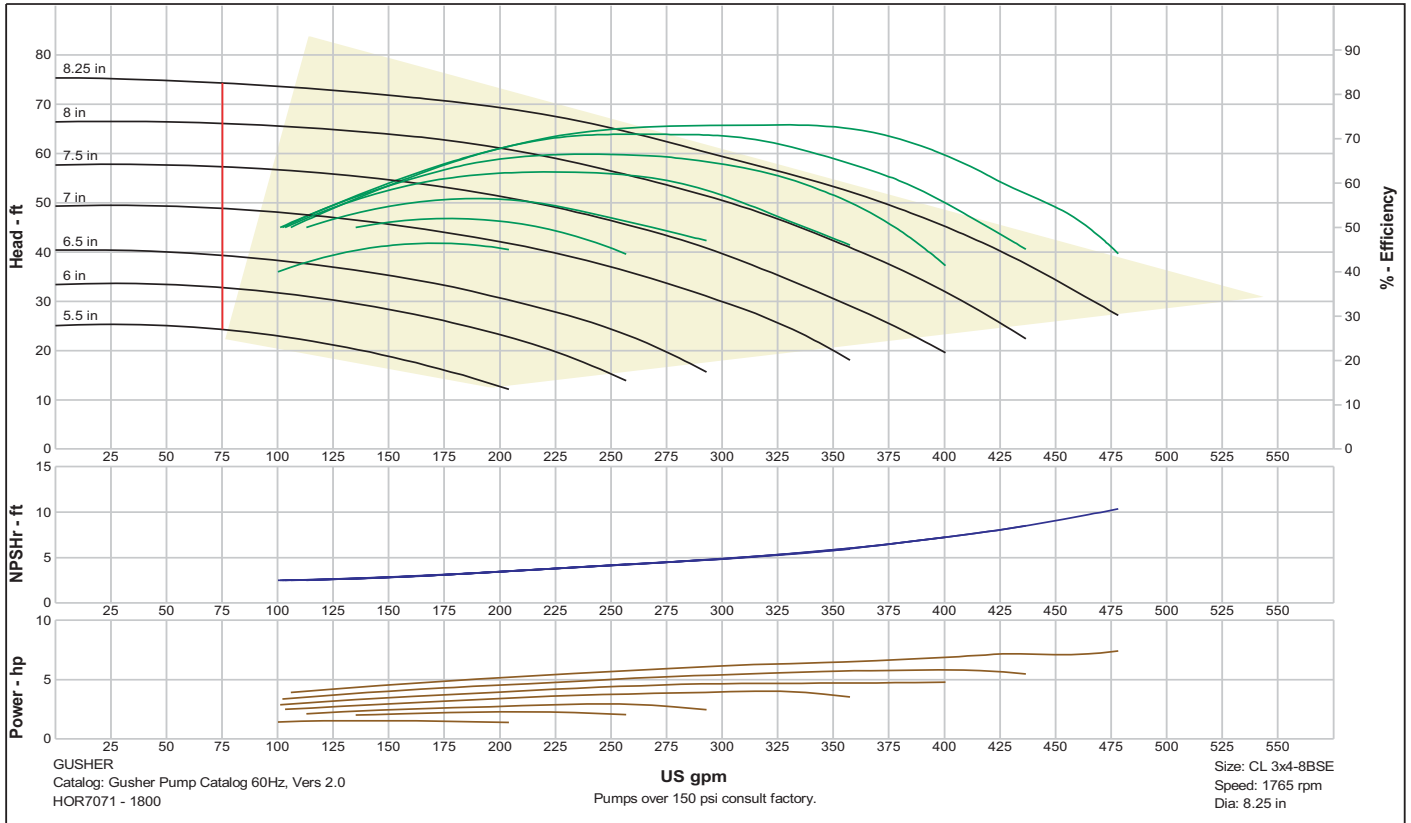

7071M CL 3x4-8BSE 3400 rpm

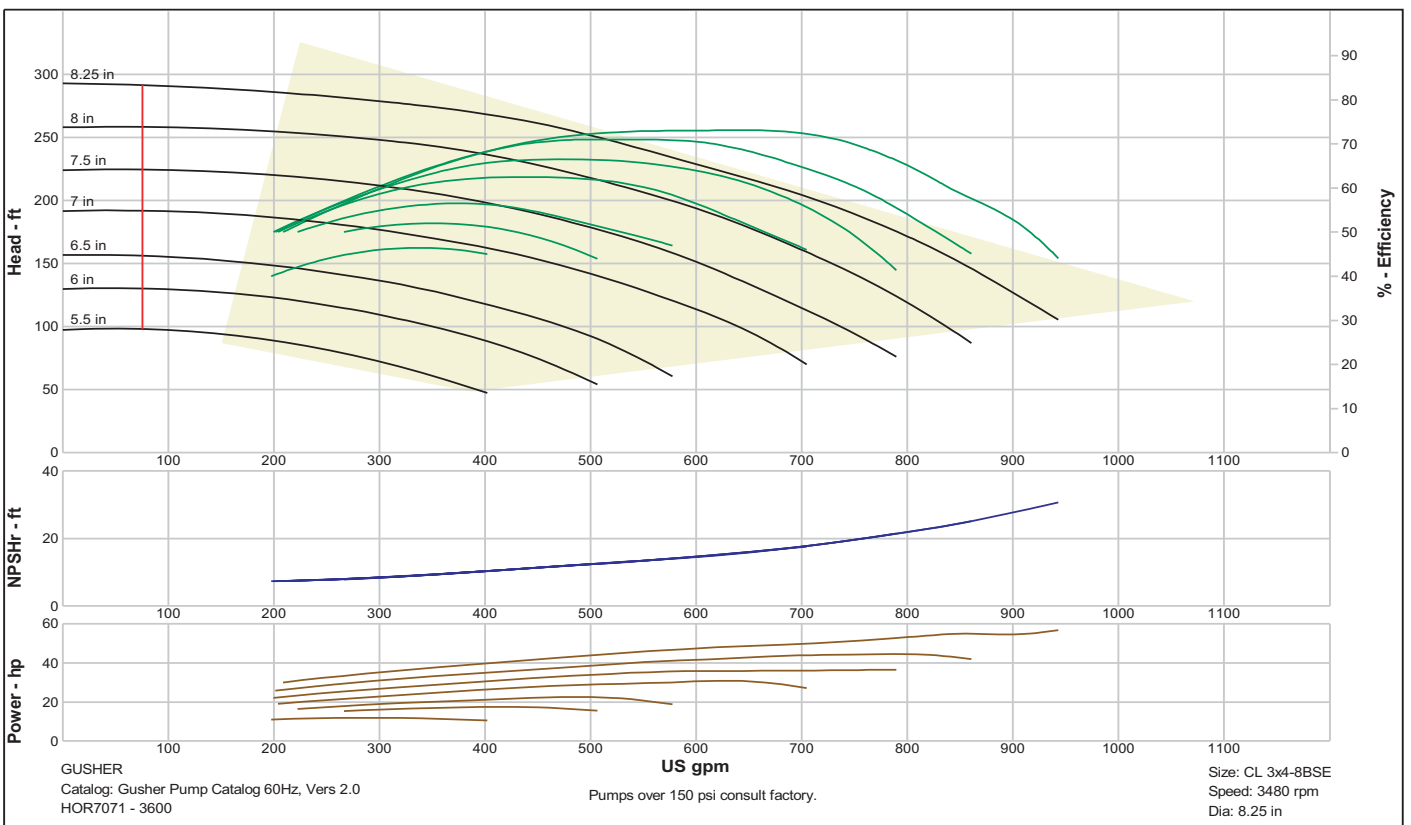

Pump Selection Curves

7071M CL 5x6-9SE 1765 rpm

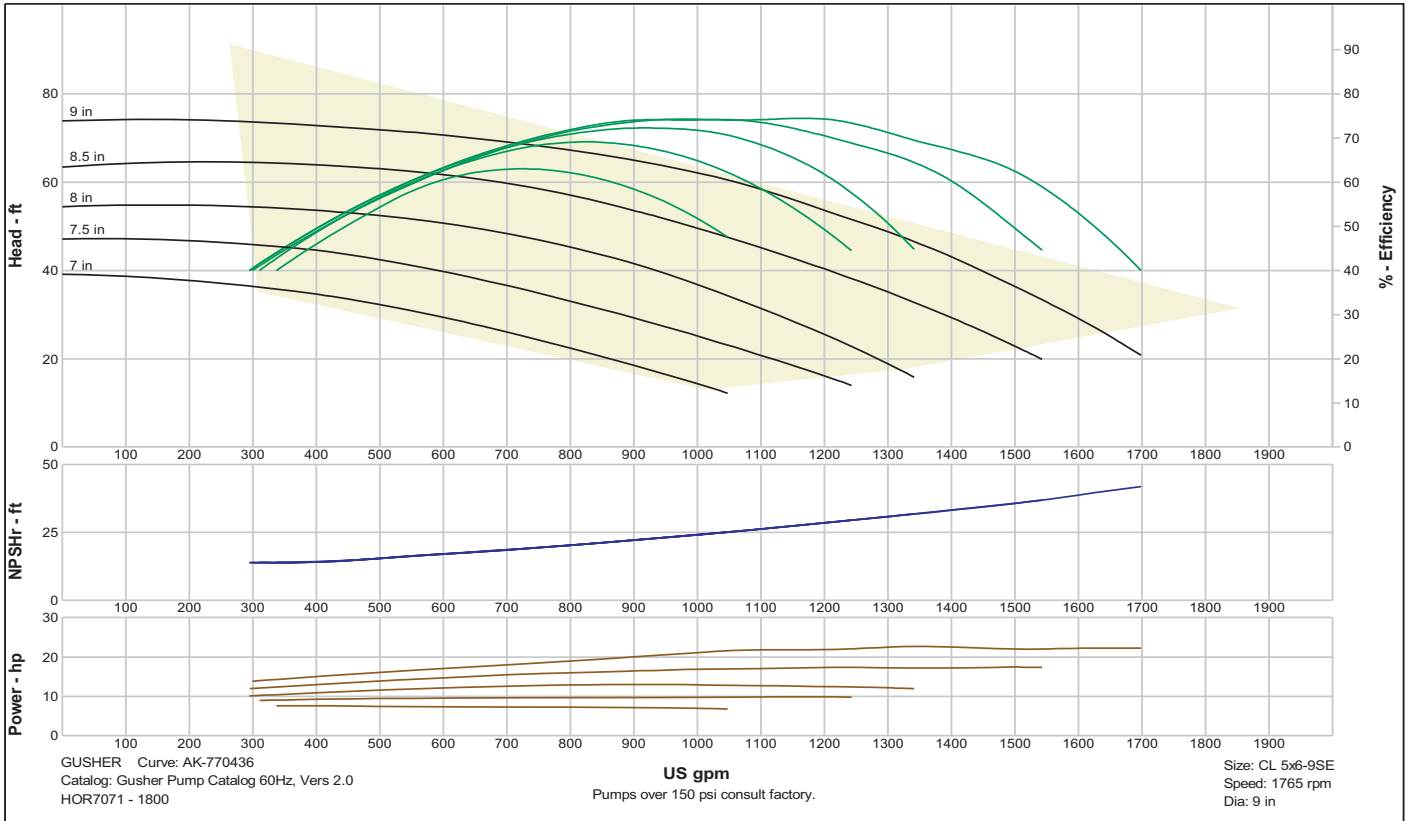

7071M CL 1x2-10SE 1765 rpm

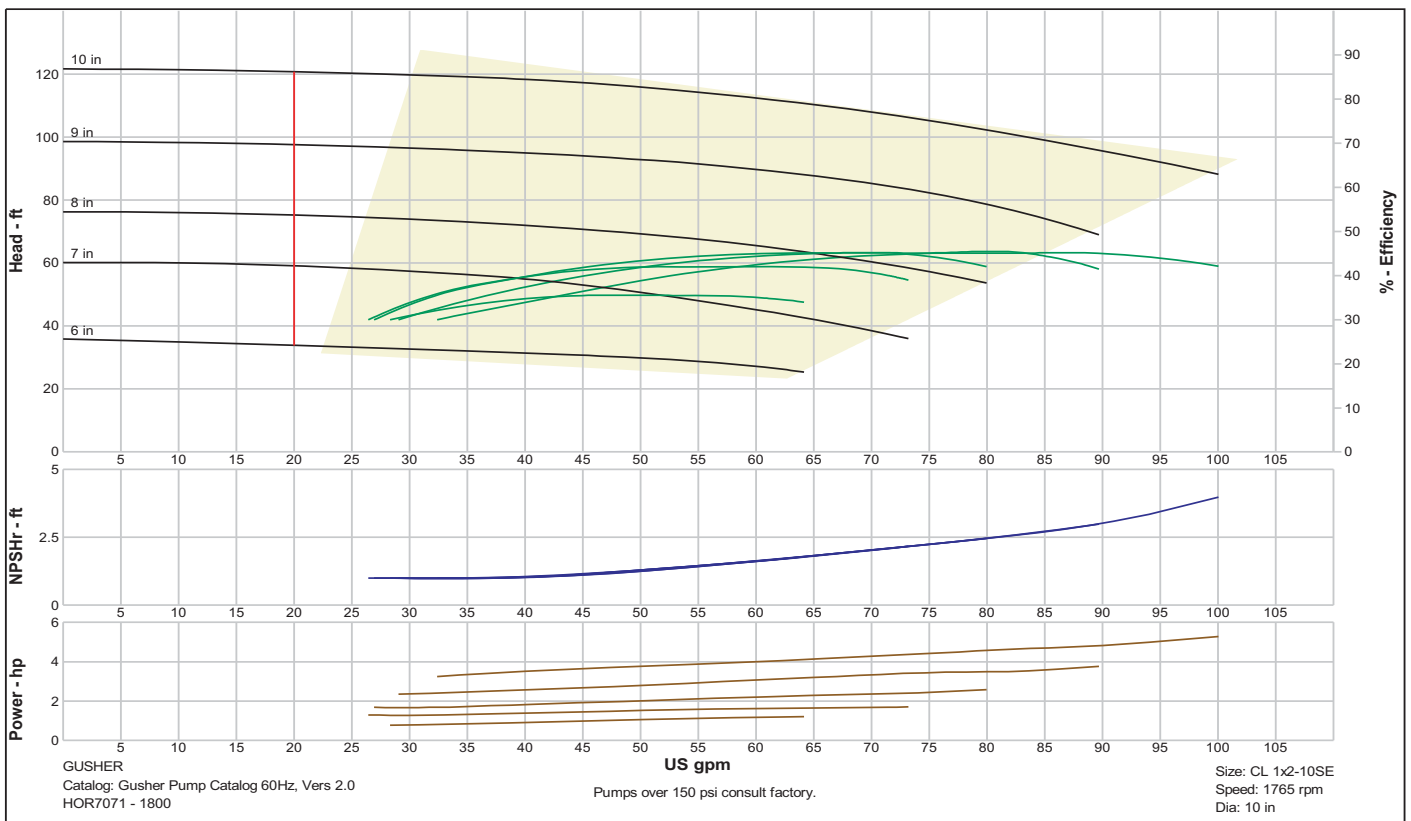

Pump Selection Curves

7071M CL 1x2-10SE 3480 rpm

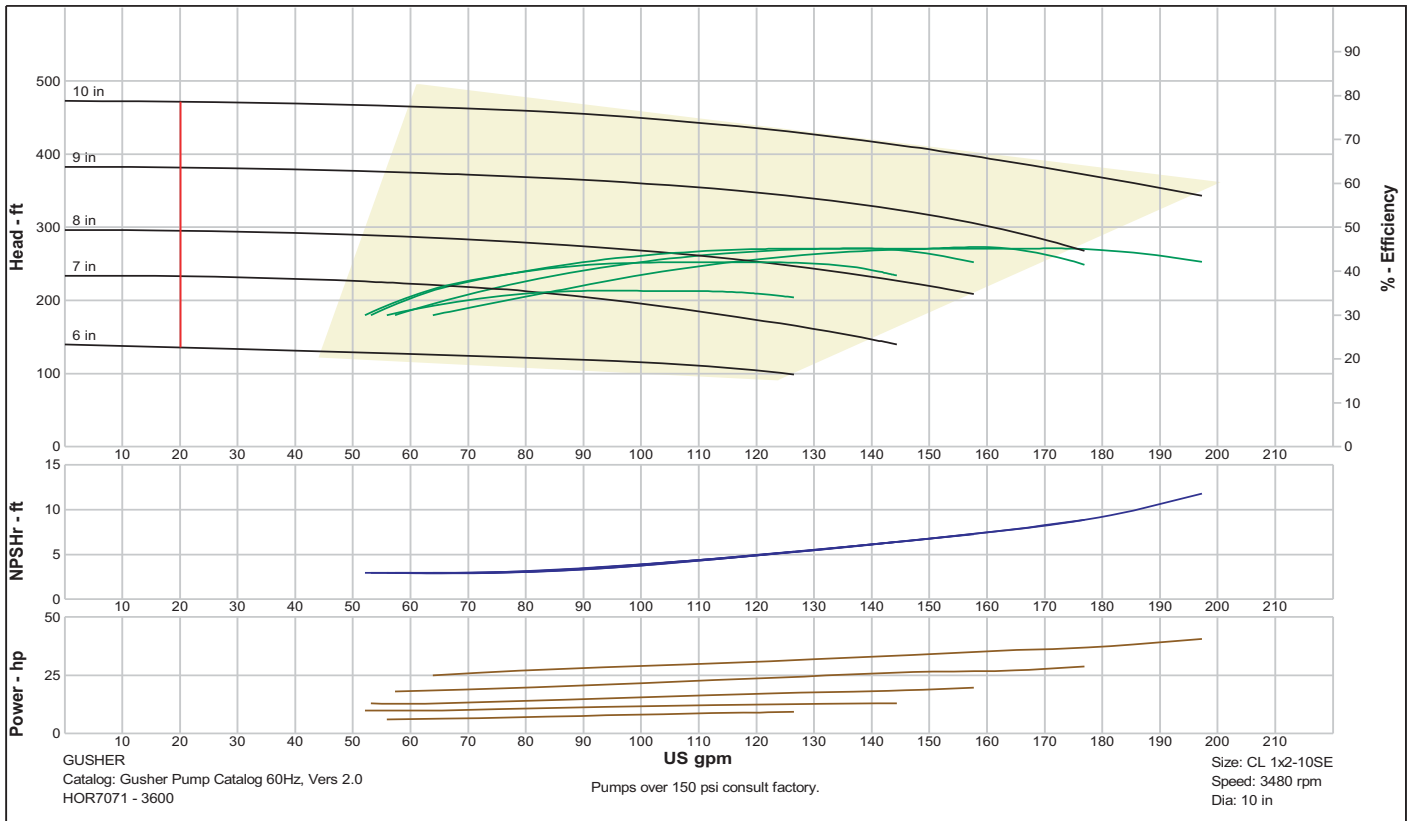

7071M CL 1.5x3-10SE 1765 rpm

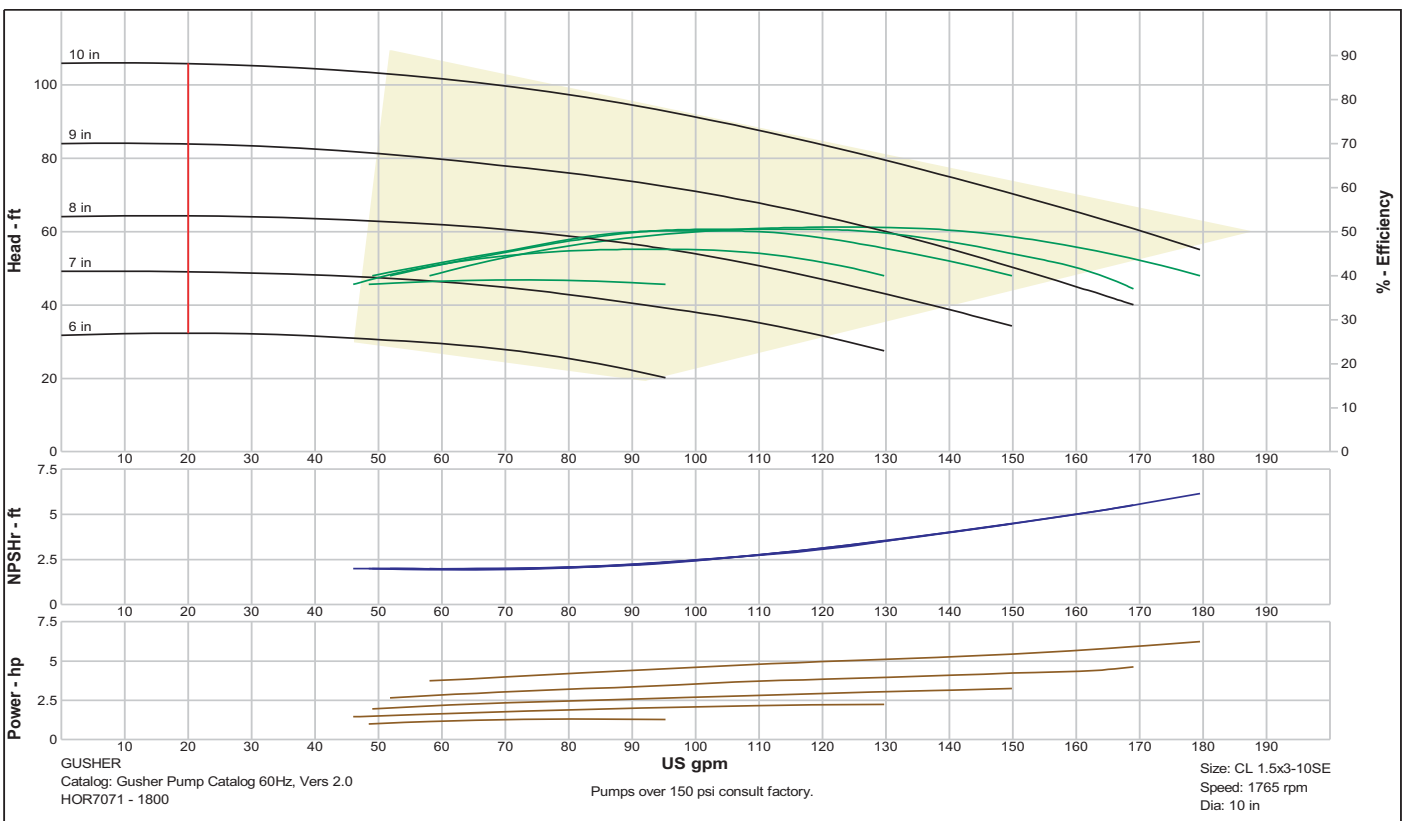

Pump Selection Curves

7071M CL 1.5x3-10SE 3480 rpm

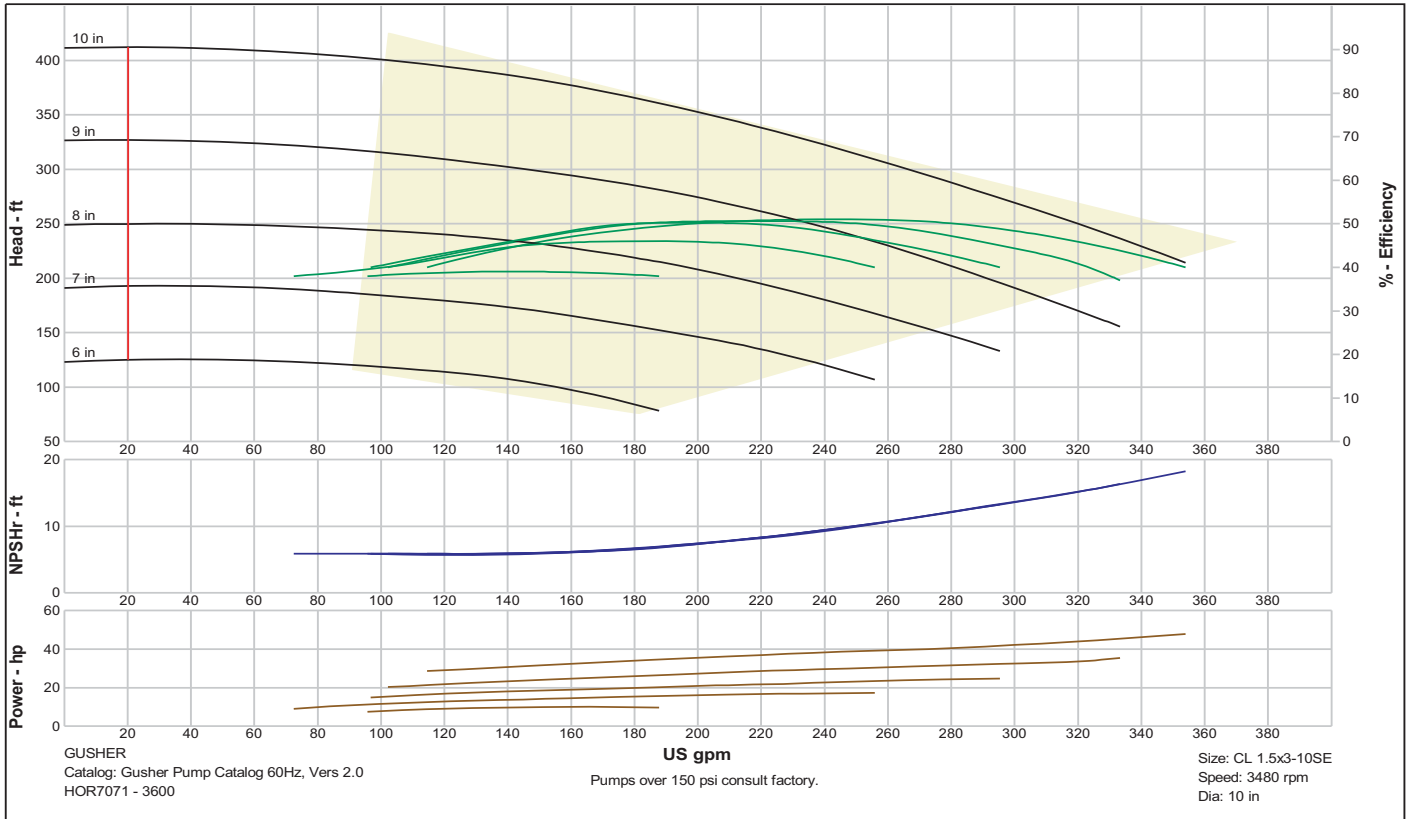

7071M CL 2x3-10SE 1765 rpm

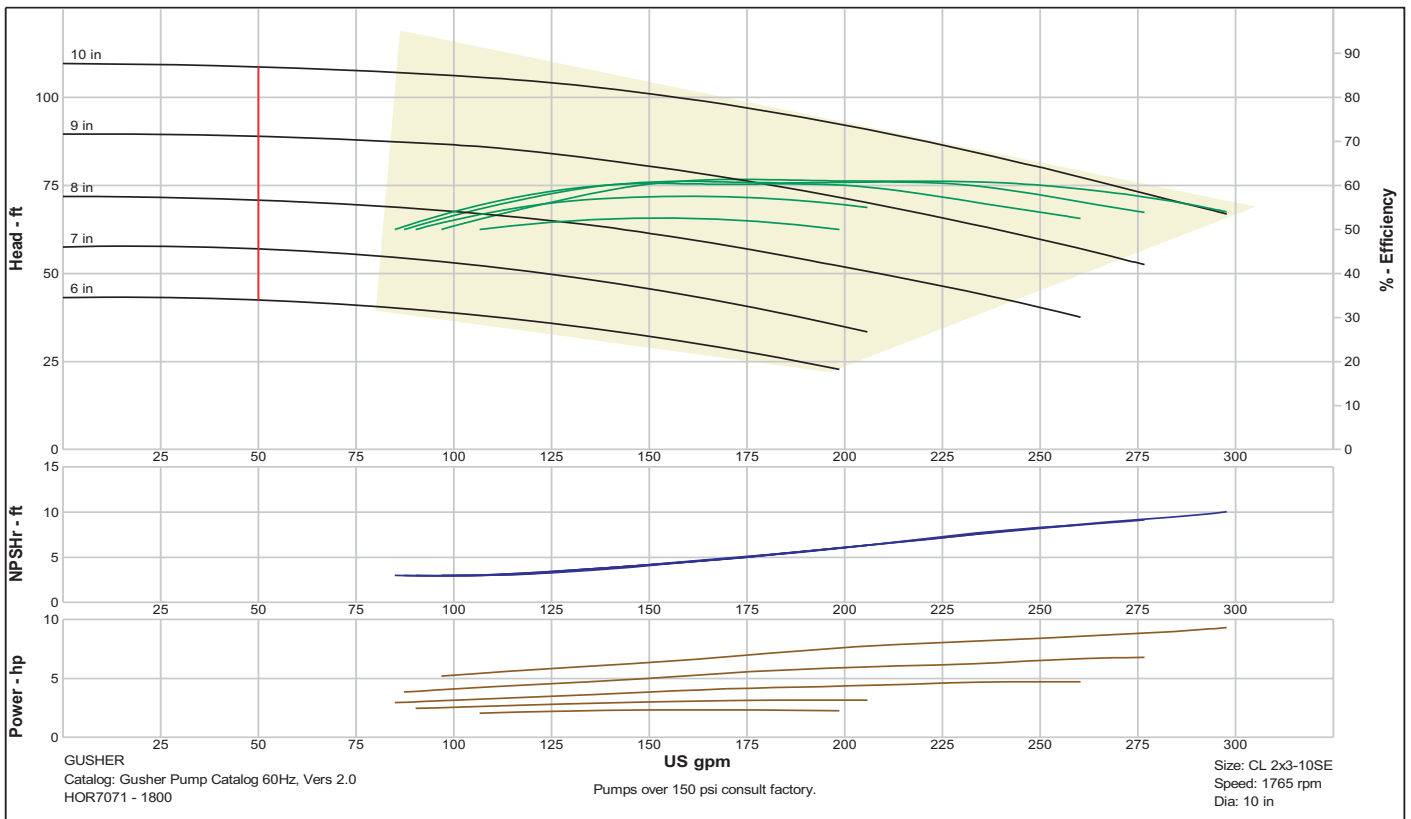

Pump Selection Curves

7071M CL 2x3-10SE 3480 rpm

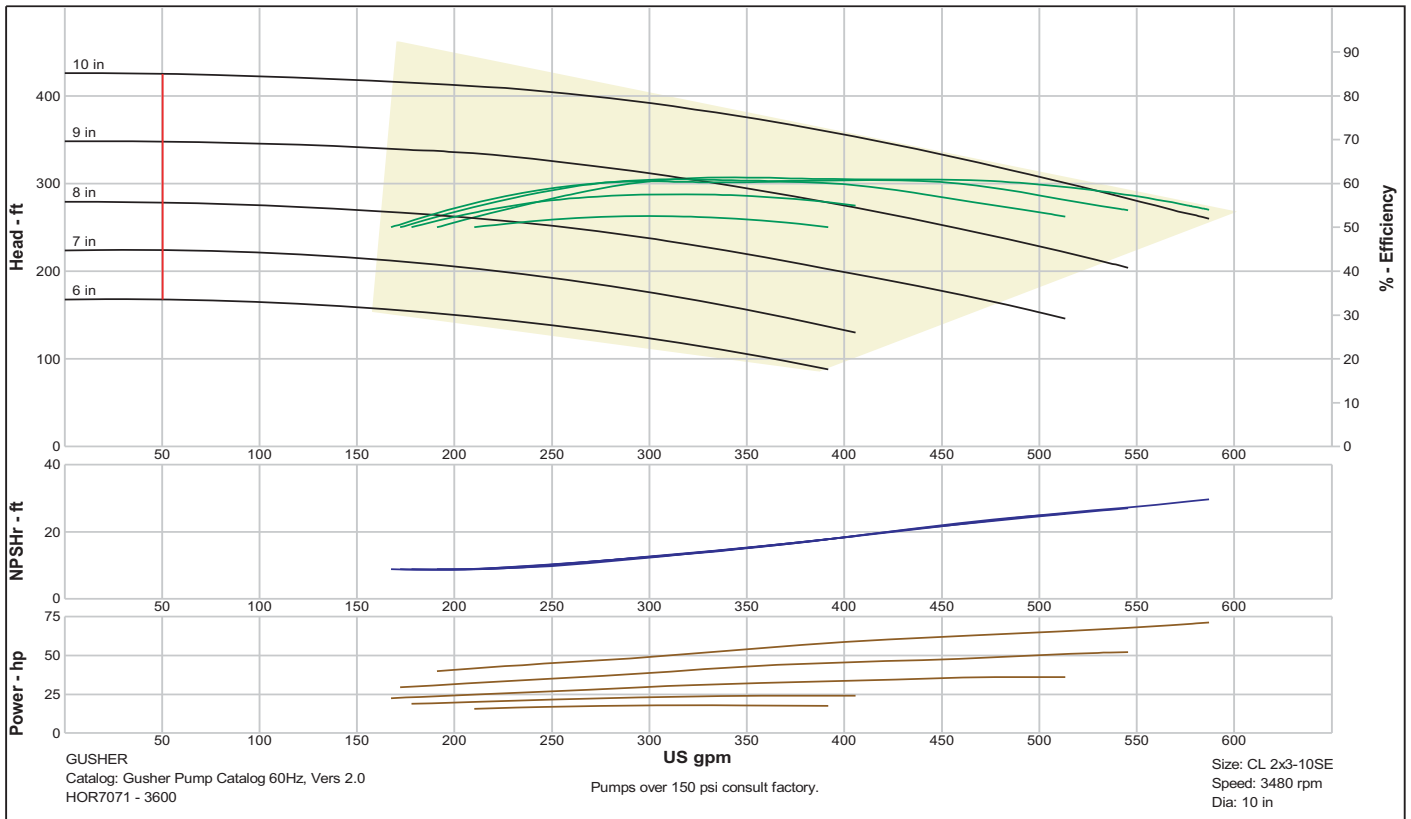

7071M CL 3x4-10SE 1765 rpm

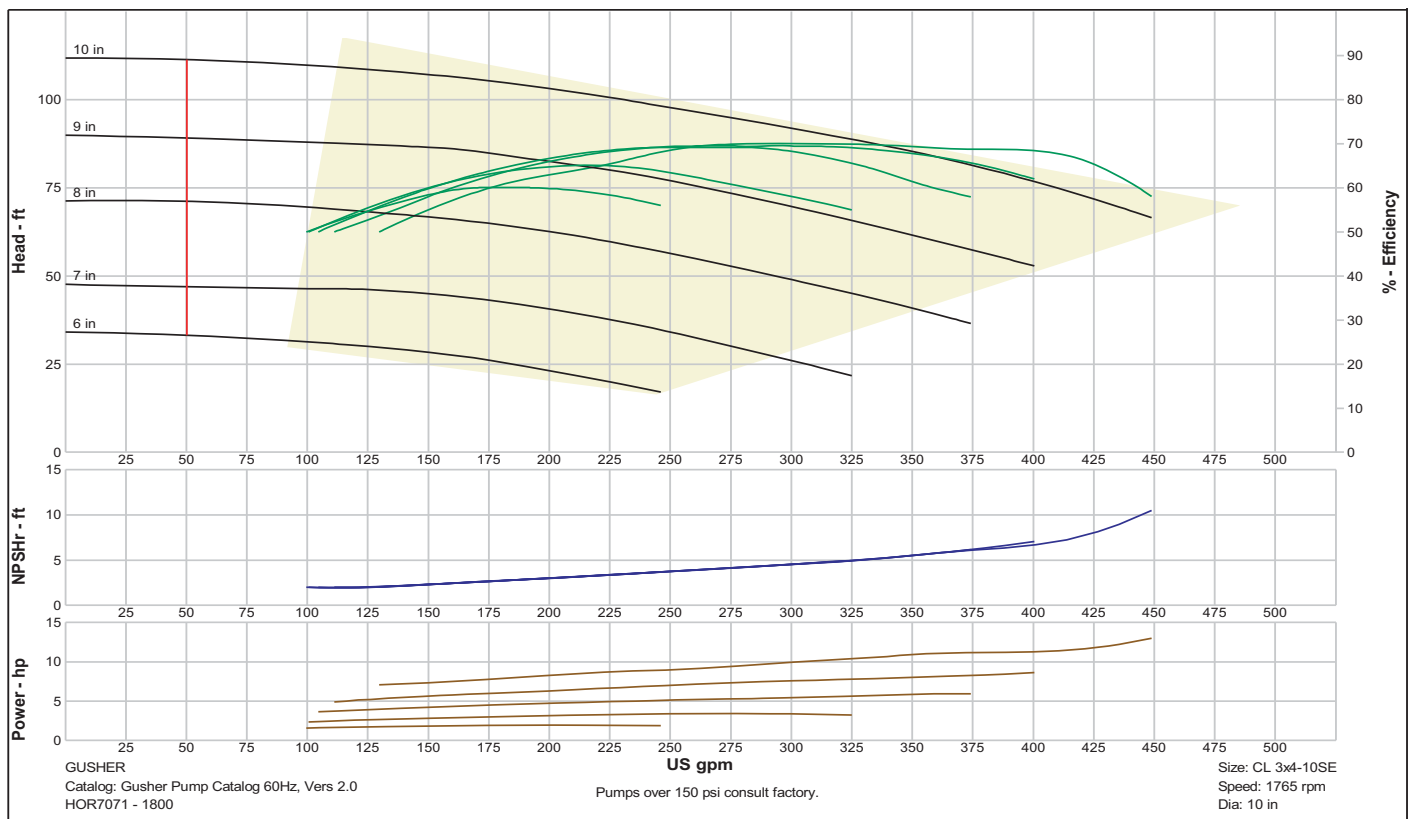

Pump Selection Curves

7071M CL 3x4-10SE 3480 rpm

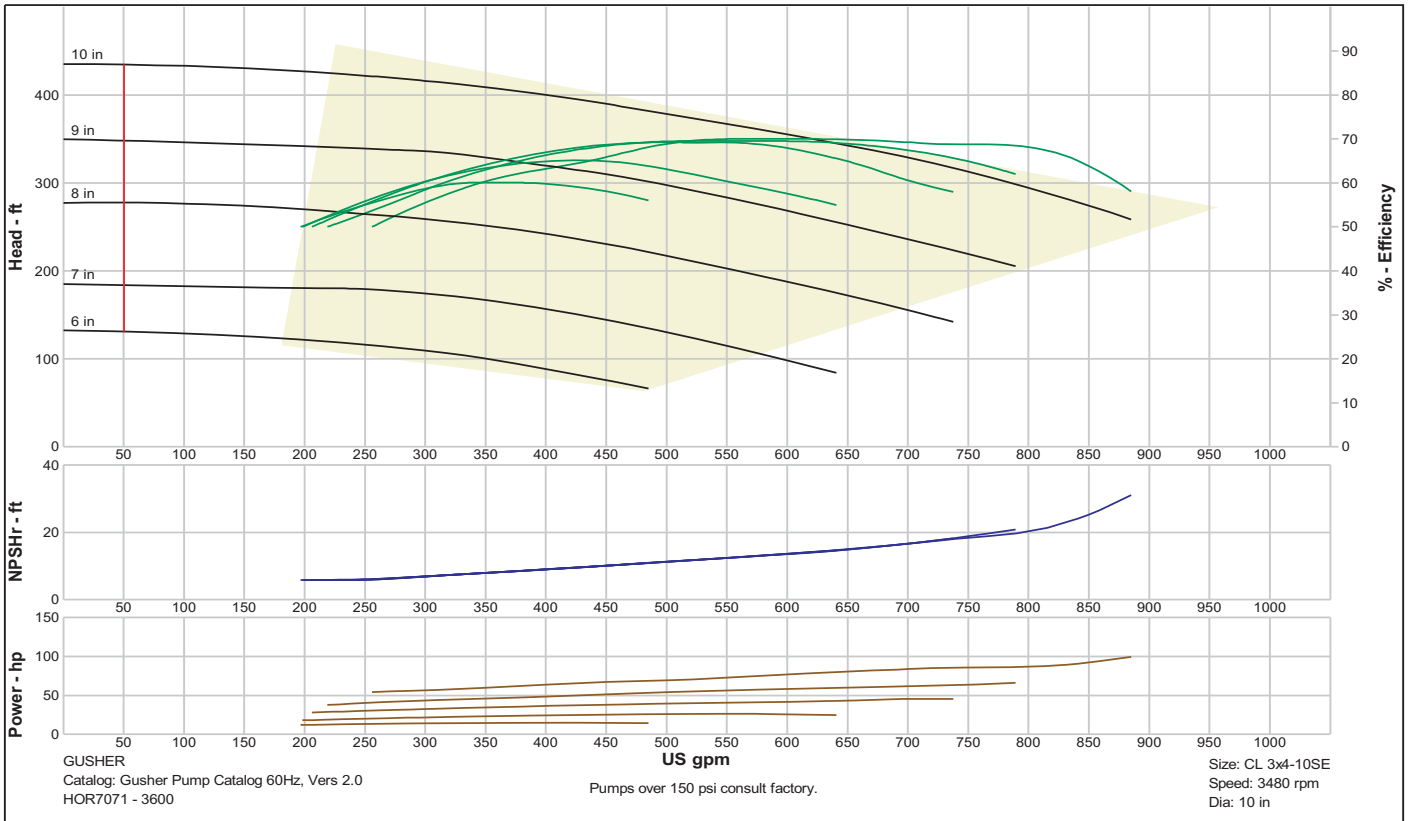

7071M CL 3x4-10BSE 1765 rpm

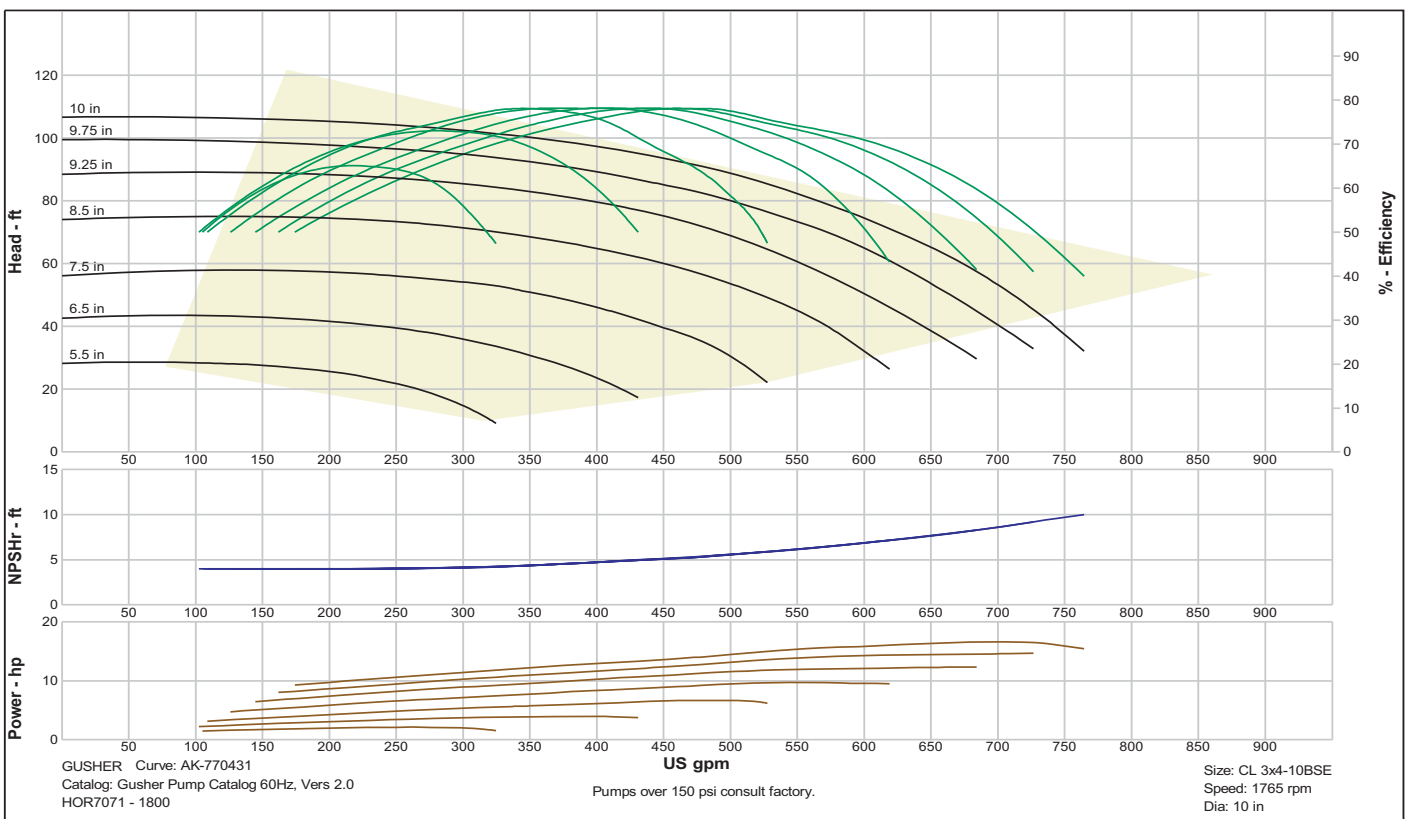

Pump Selection Curves

7071M CL 4x6-10SE 1765 rpm

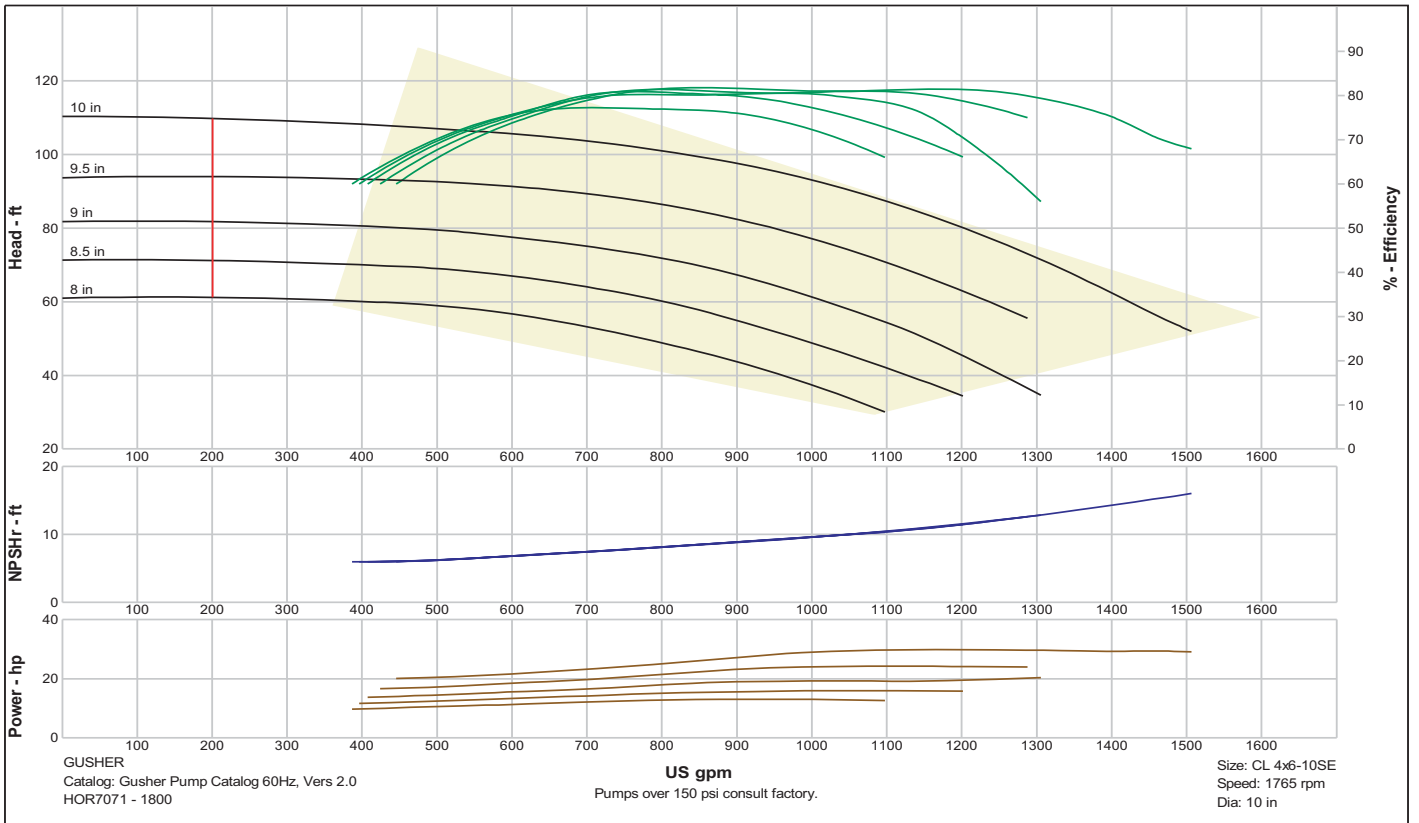

7071M CL 4x6-10BSE 1765 rpm

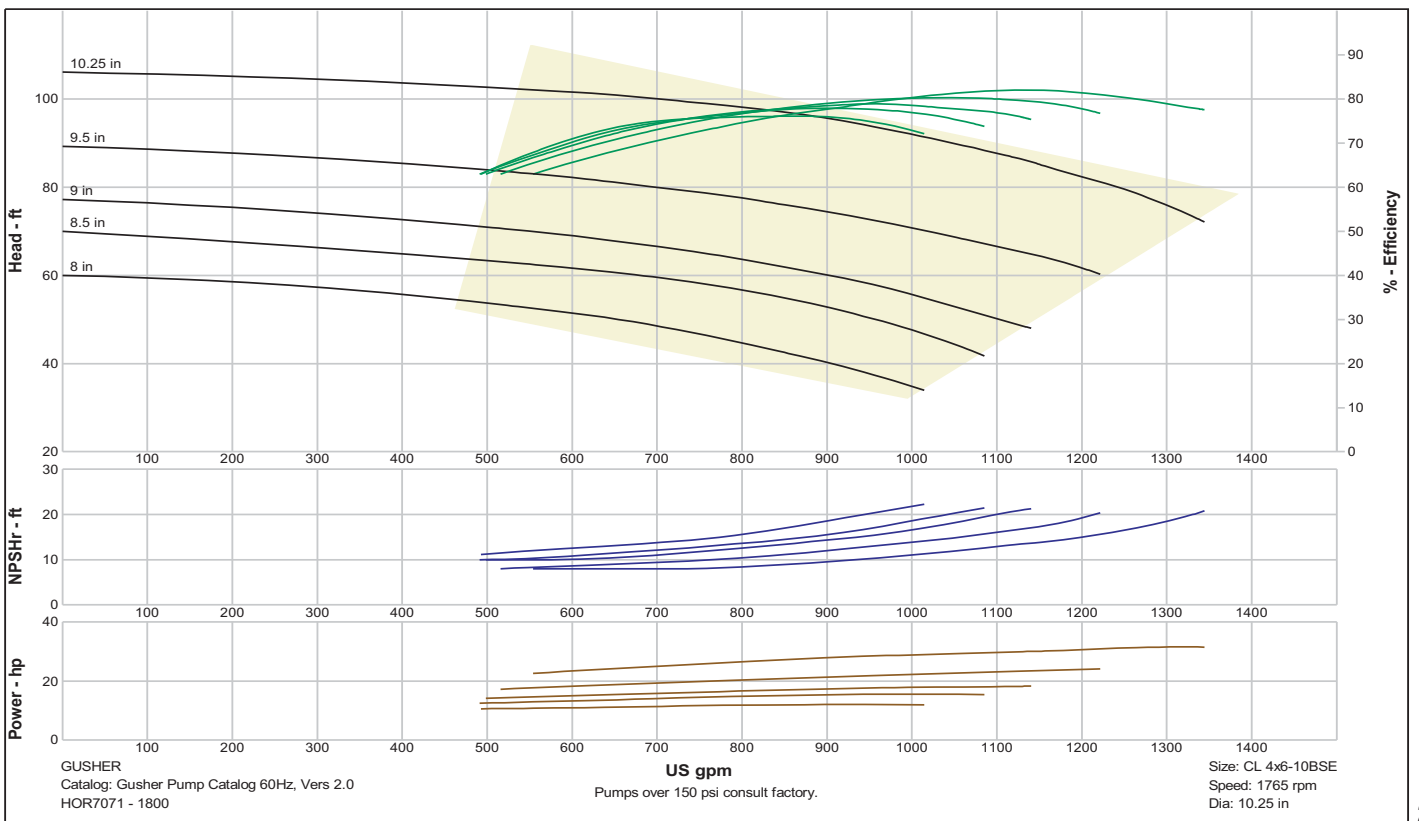

Pump Selection Curves

7071M CL 4x6-10BSE 3480 rpm

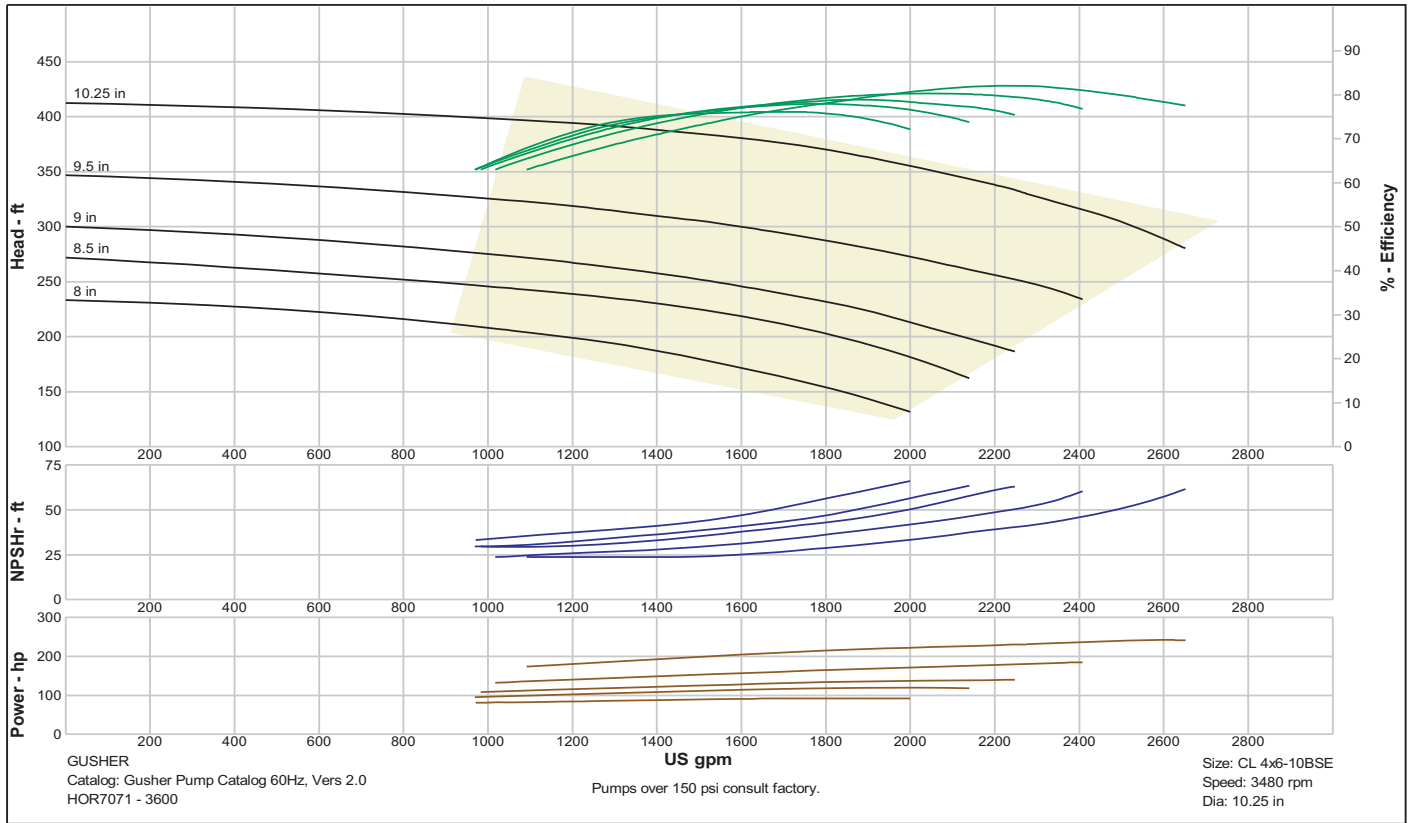

7071M CL 4x5-11SE 1765 rpm

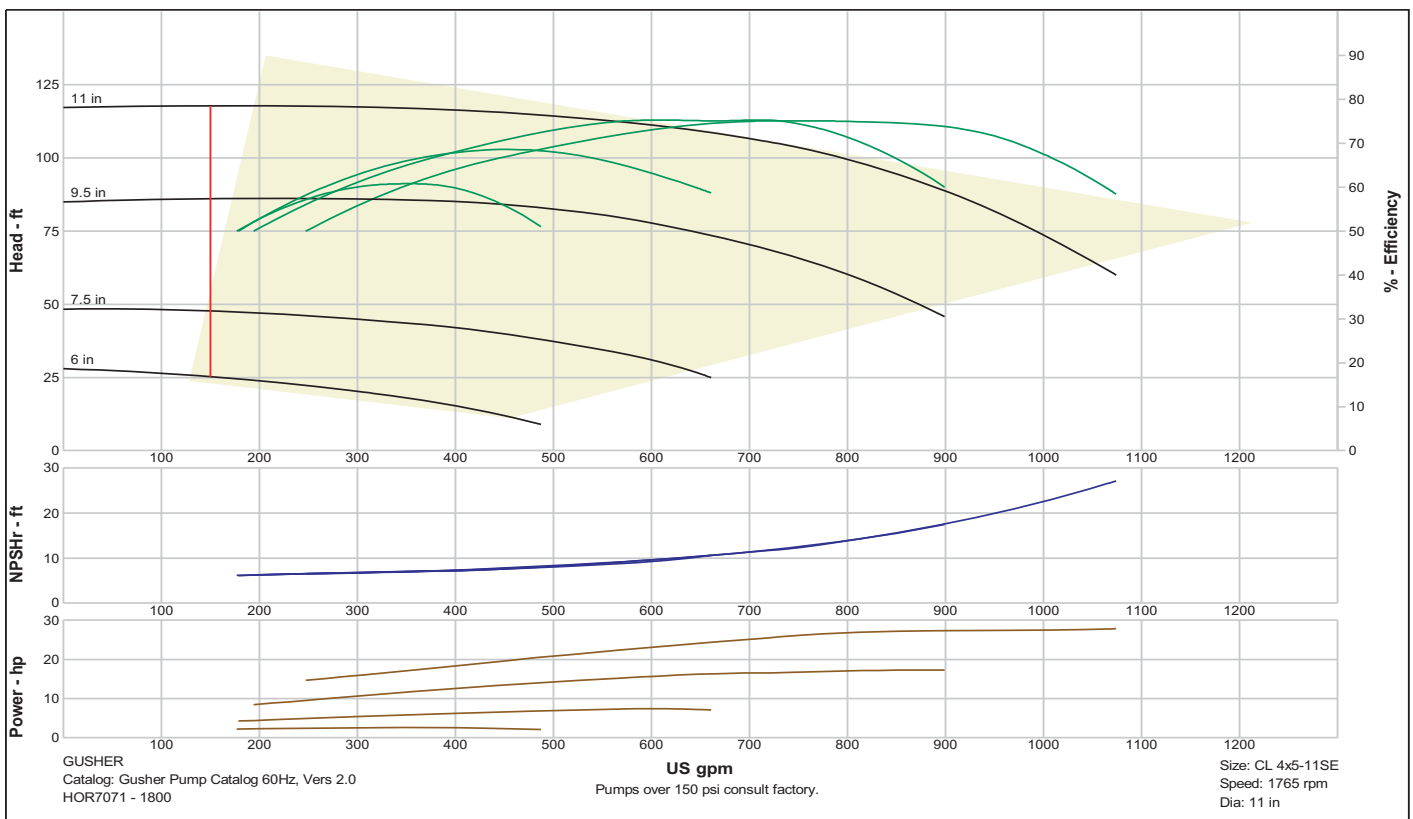

Pump Selection Curves

7071M CL 6x8-11SE 1765 rpm

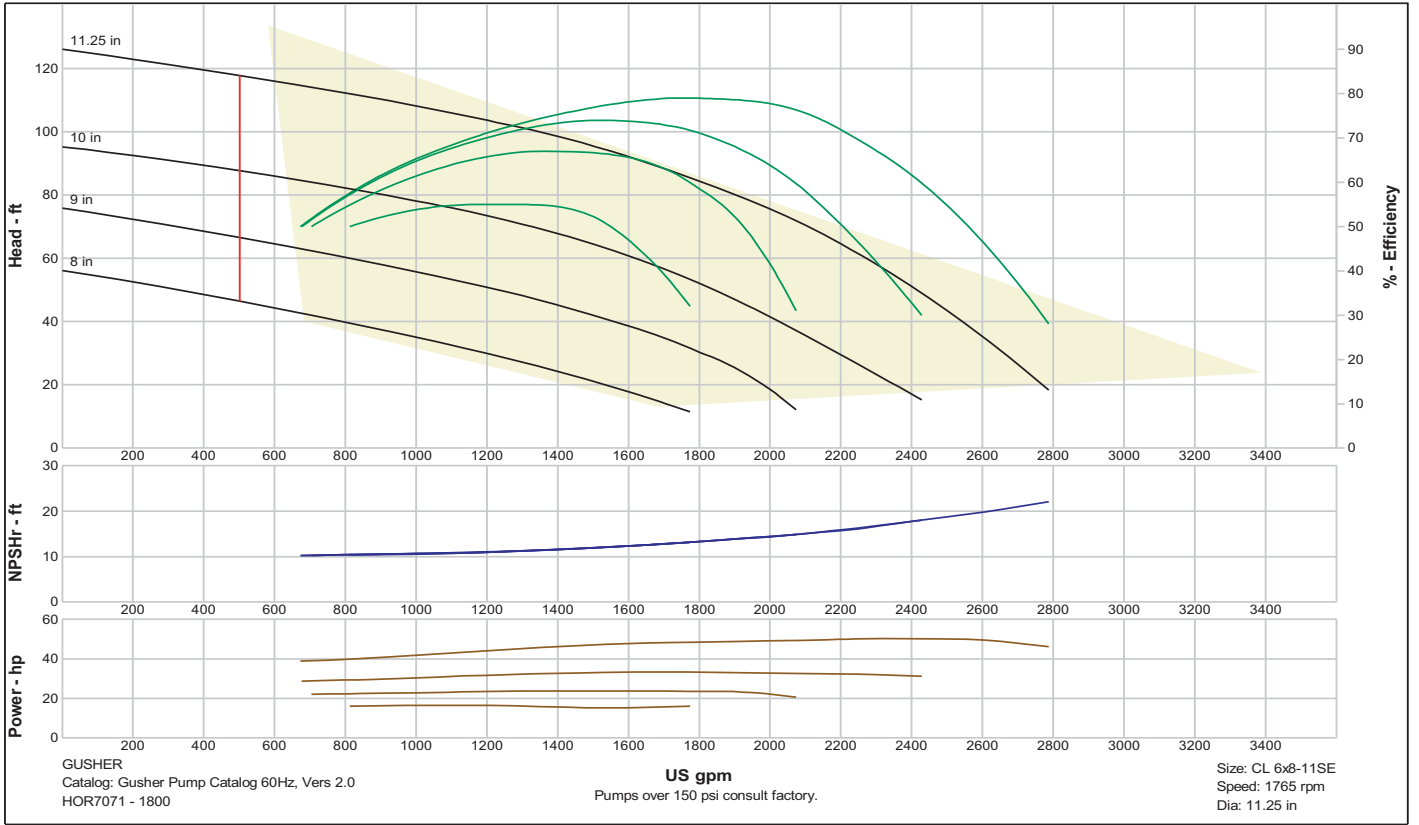

7071M CL 1.5x3-13SE 1765 rpm

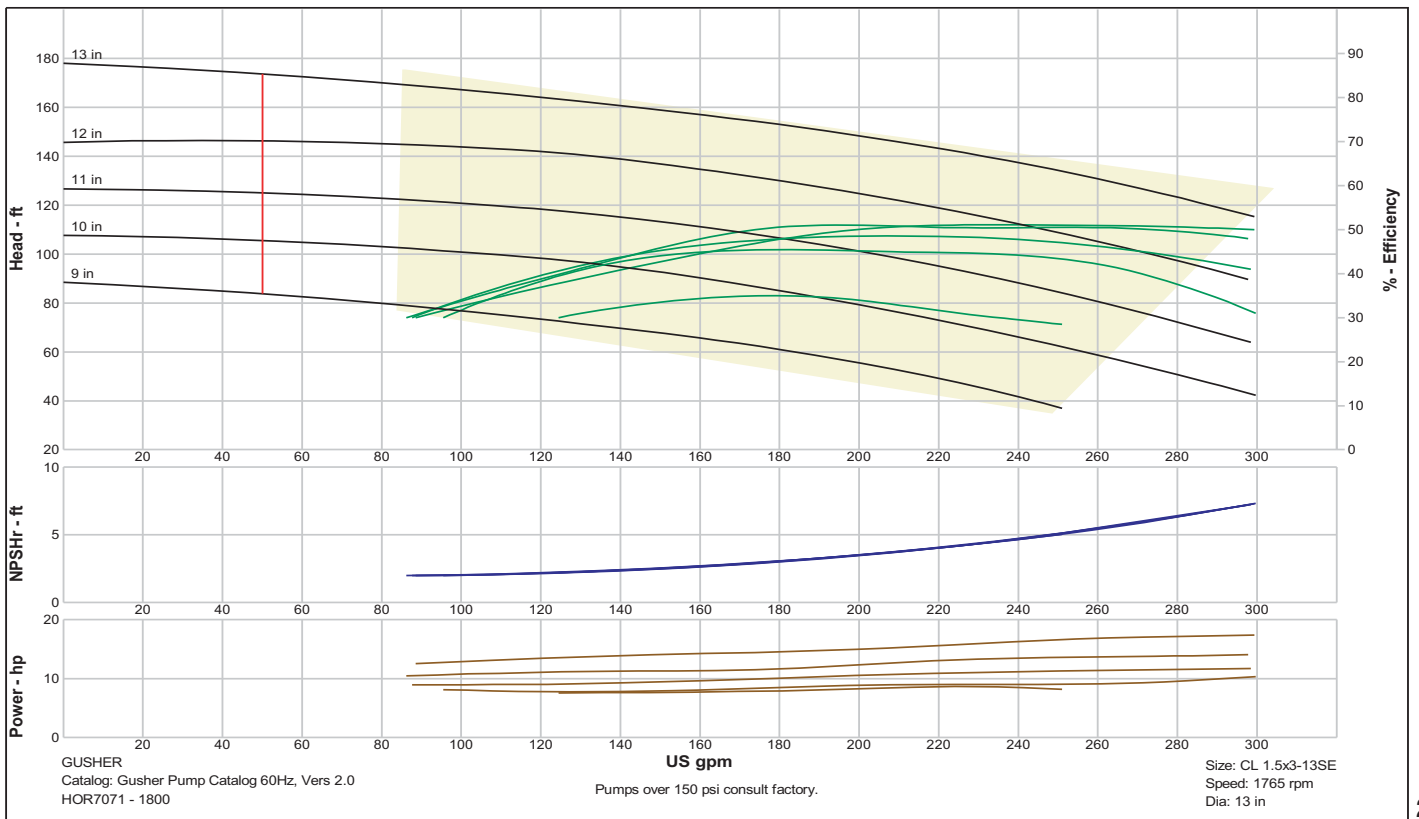

Pump Selection Curves

7071M CL 1.5x3-13SE 3480 rpm

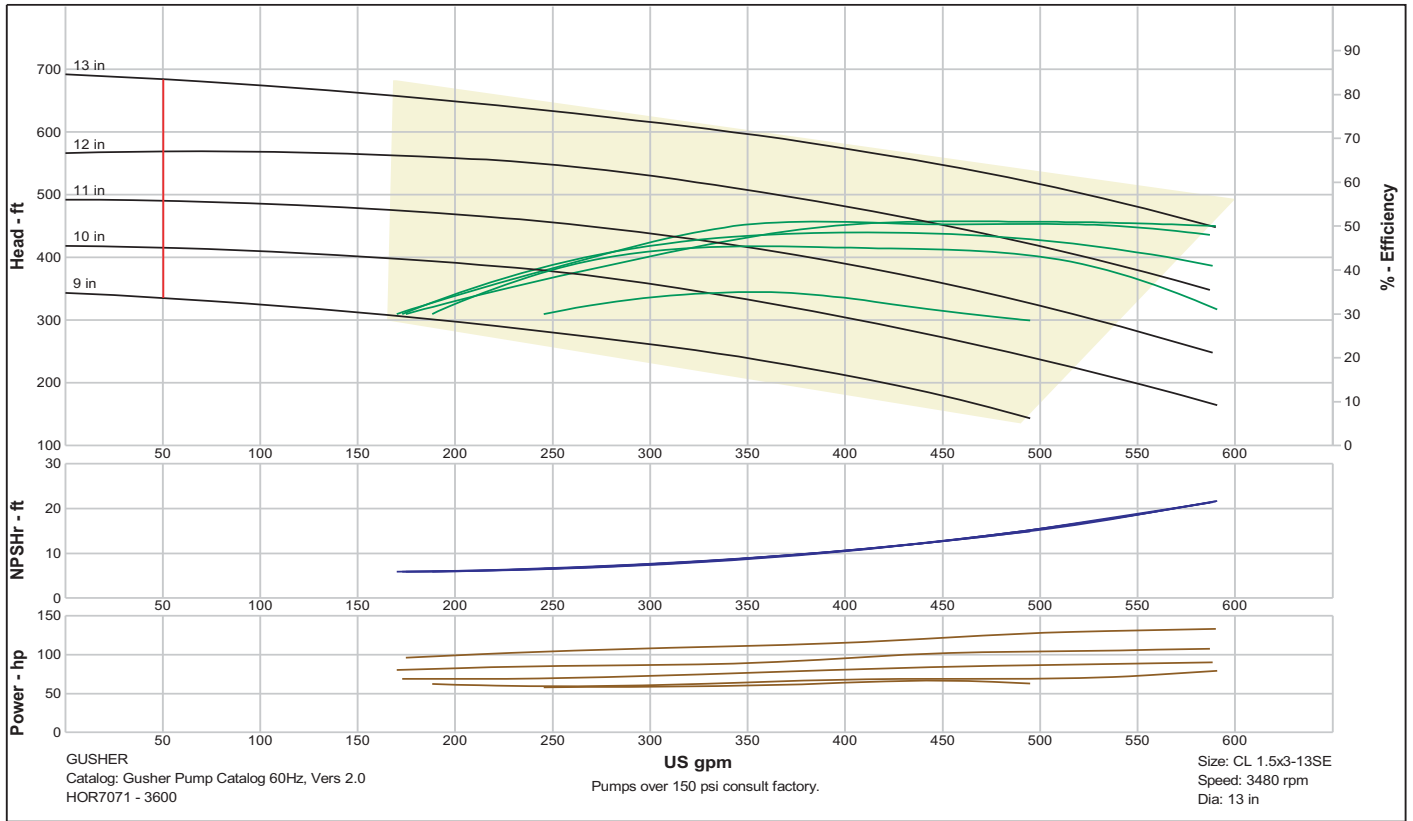

7071M CL 1.5x3-13SE 3480 rpm

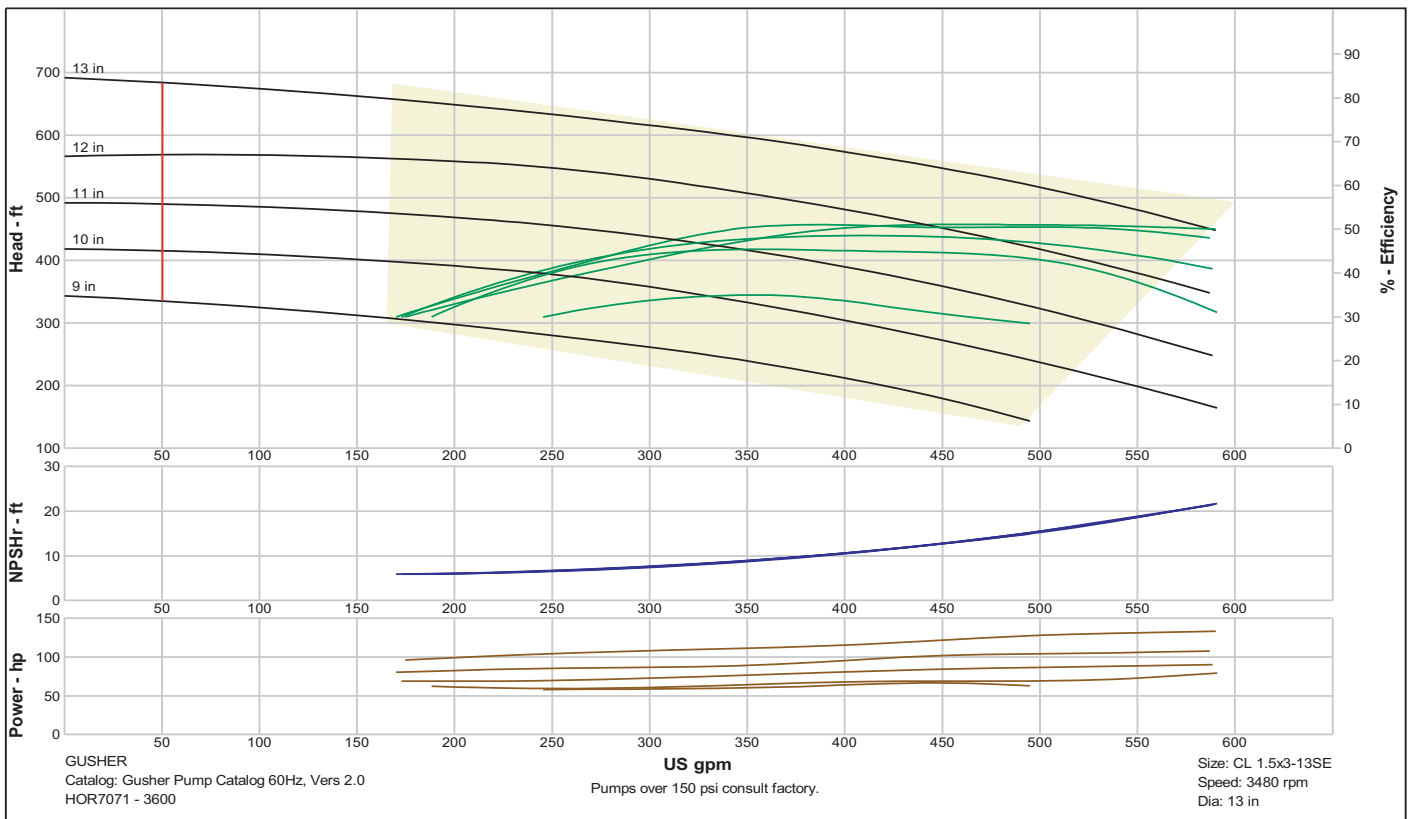

Pump Selection Curves

7071M CL 2x3-13SE 3480 rpm

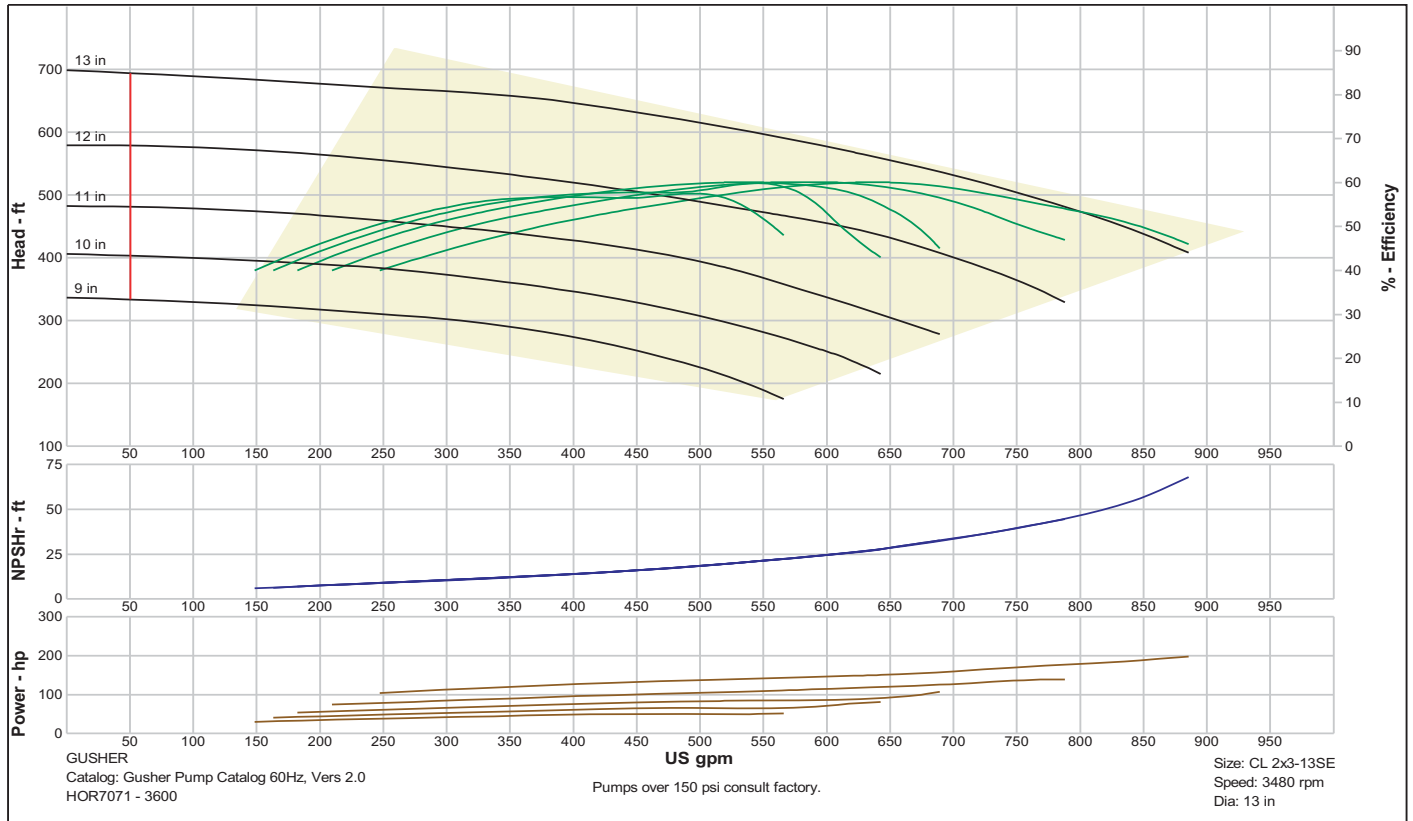

7071M CL 3x4-13SE 1765 rpm

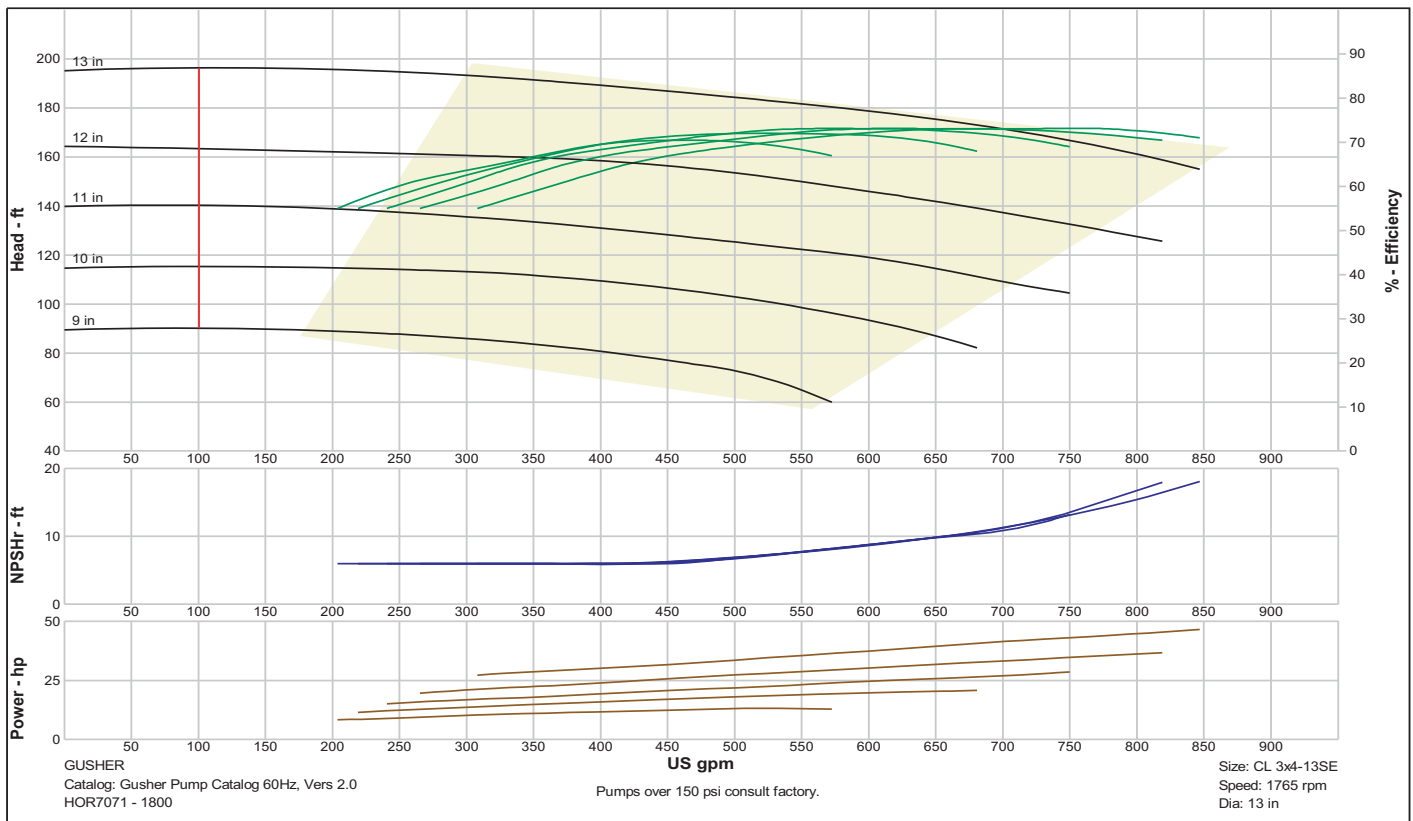

Pump Selection Curves

7071M CL 3x4-13SE 3480 rpm (10in. Impeller max.)

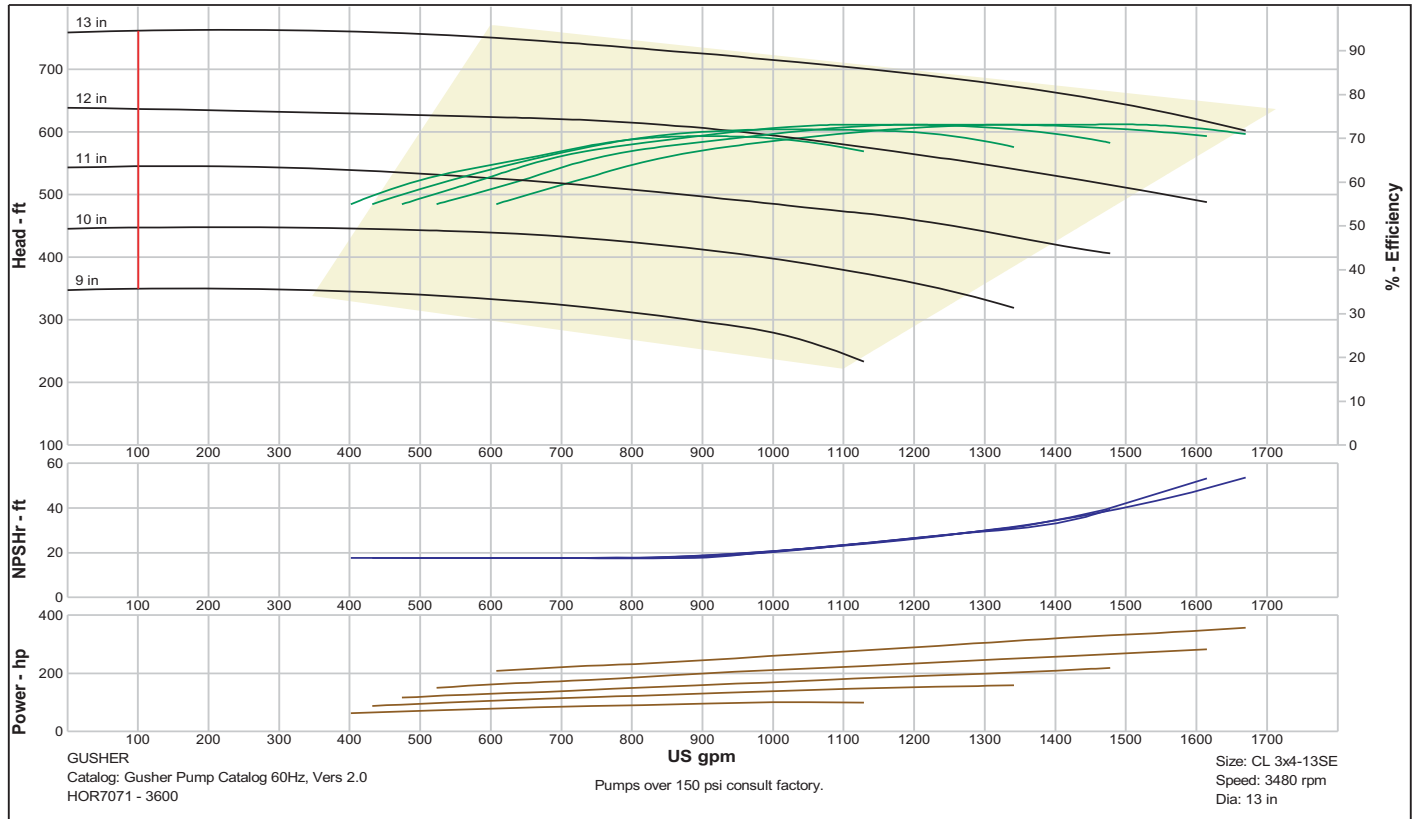

7071M CL 4x6-13SE 1765 rpm

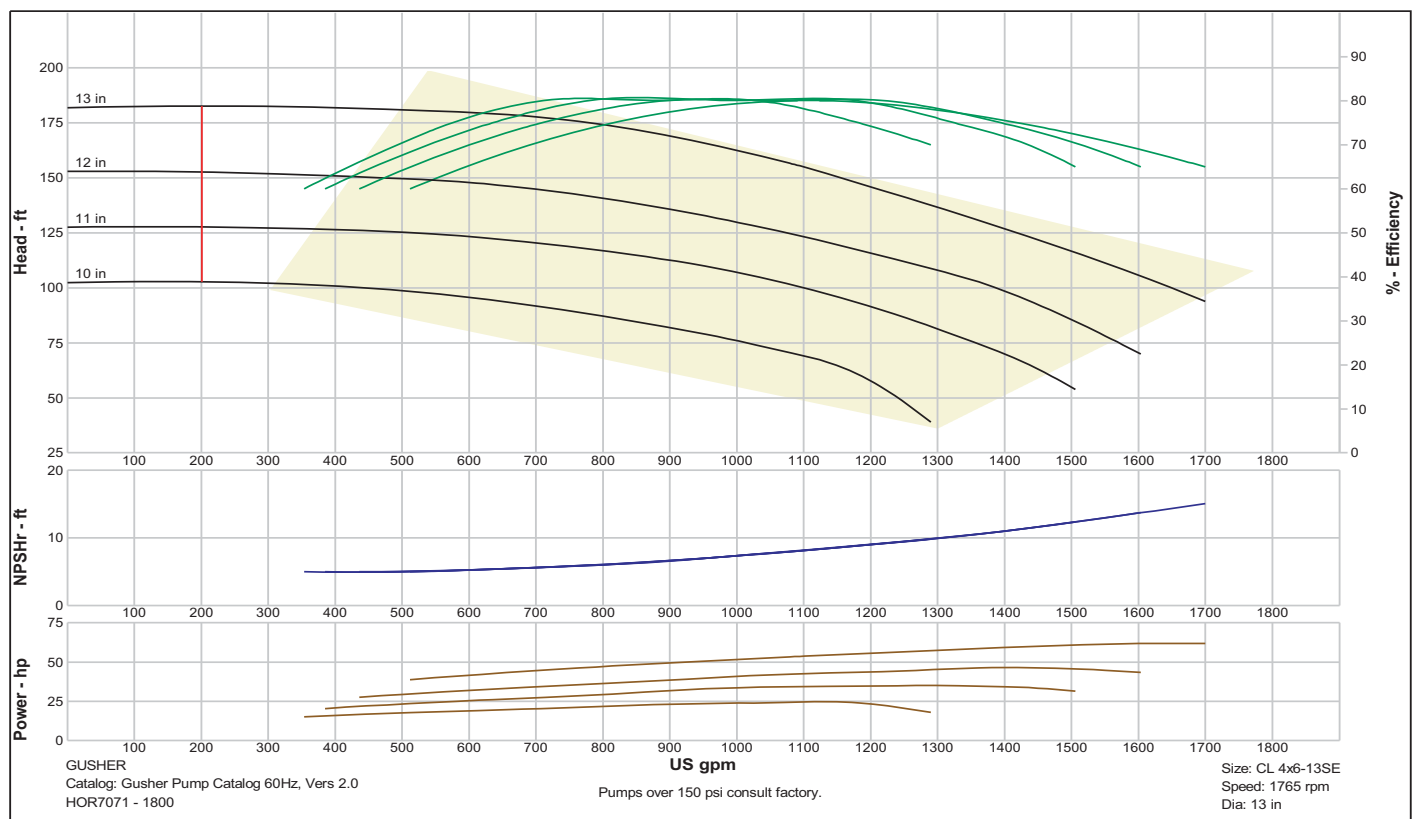

Pump Selection Curves

7071L CL 6x8-13SE 1765 rpm

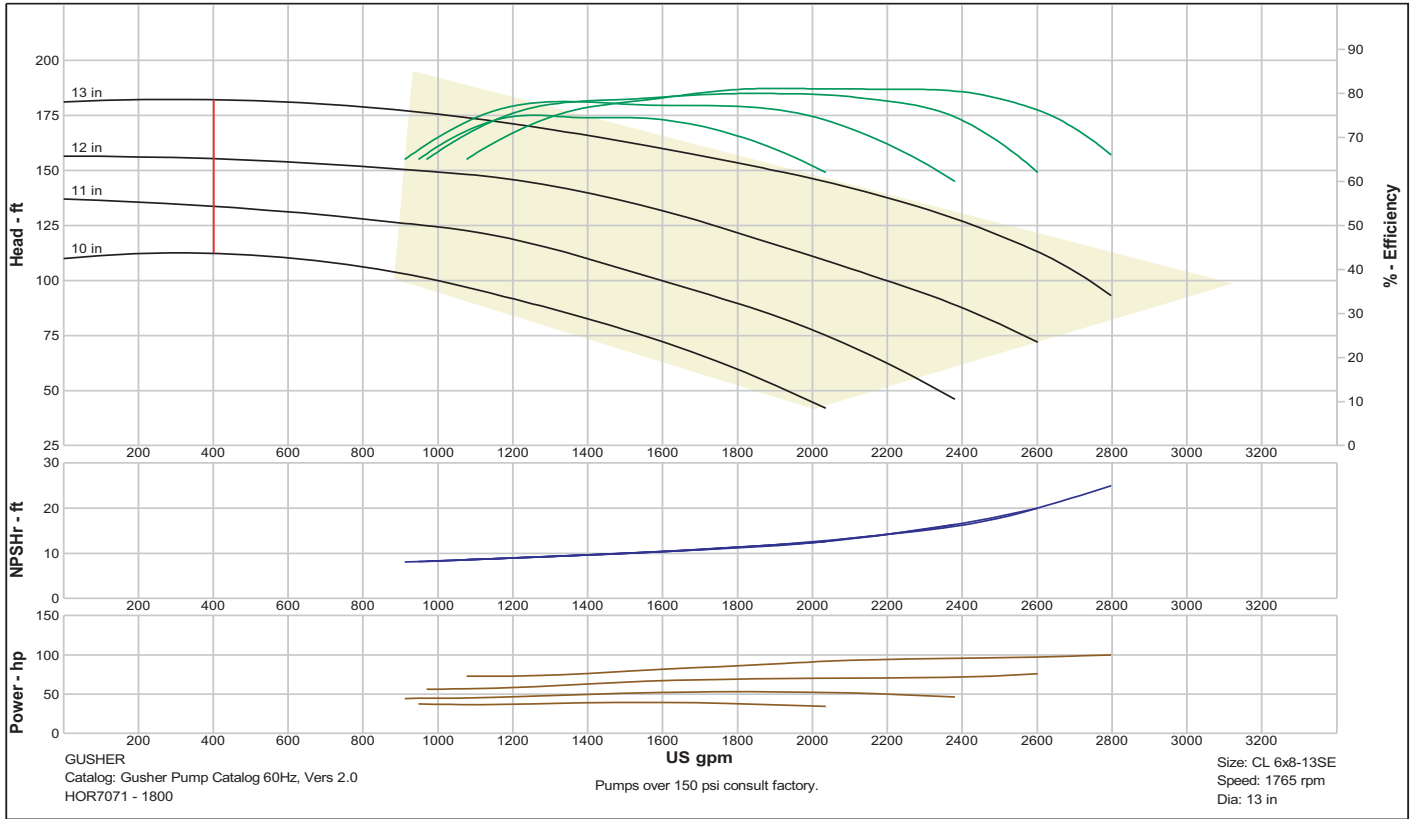

7071L CL 8x10-13SE 1765 rpm

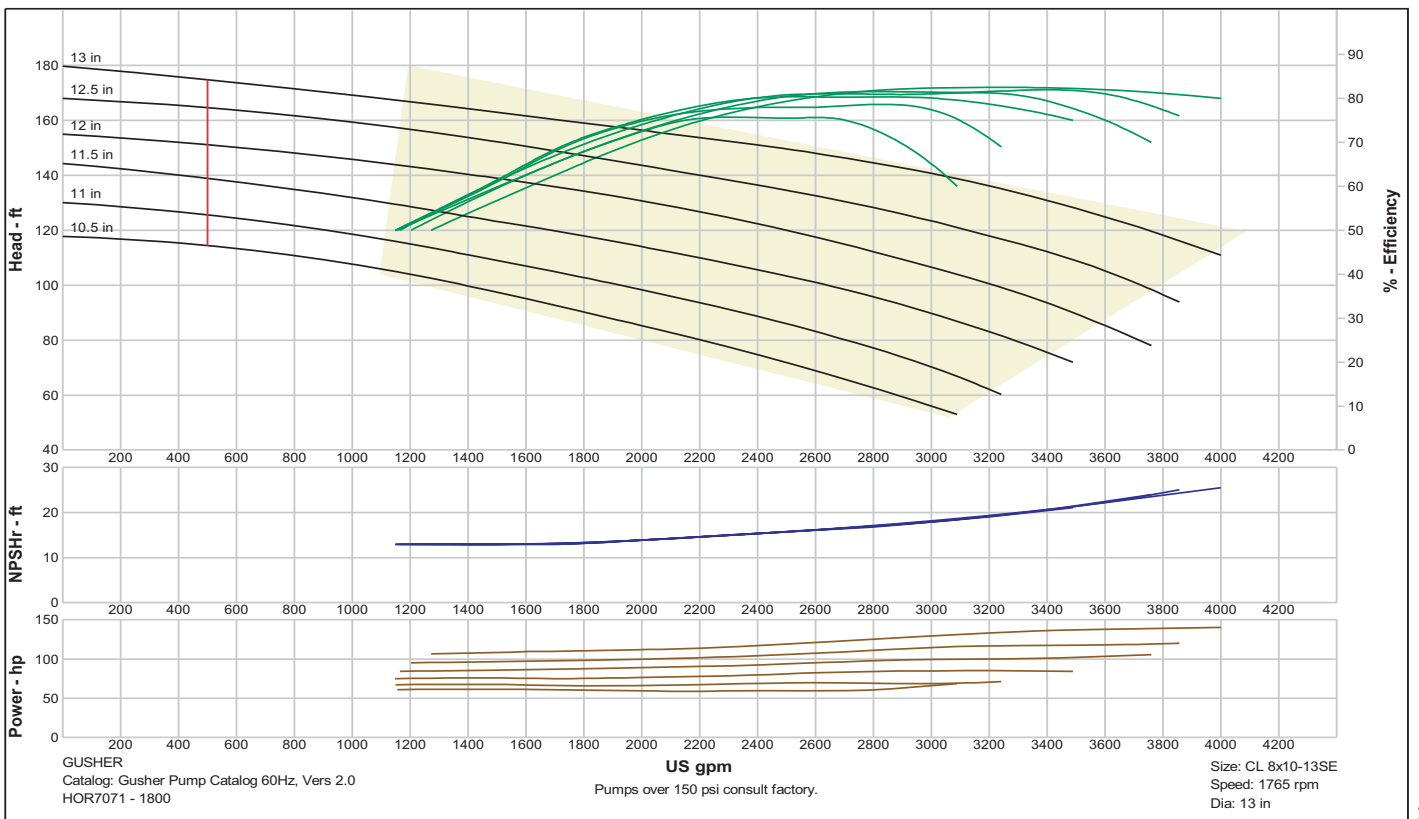

Pump Selection Curves

7071L CL 6x8-15SE 1765 rpm

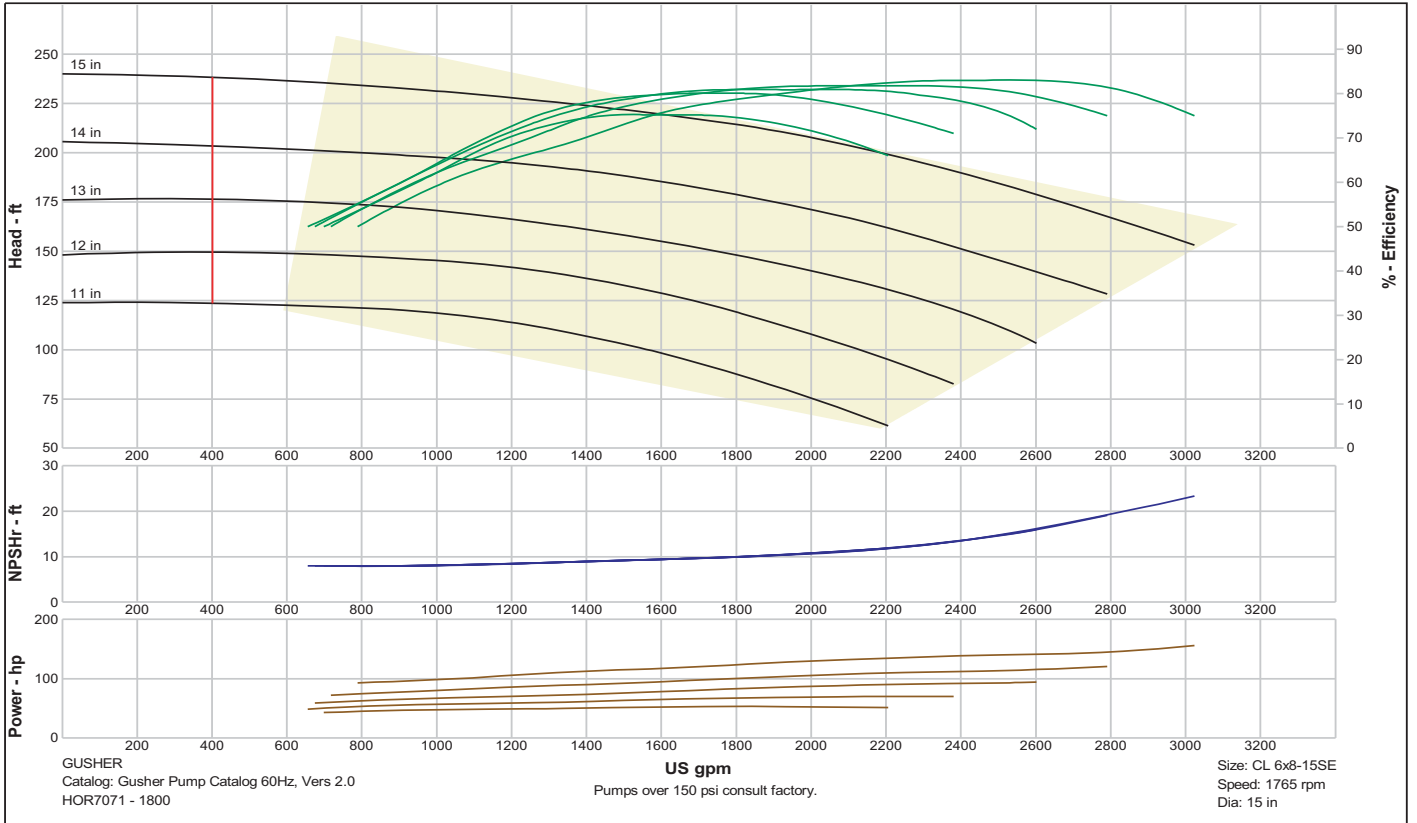

7071L CL 8x10-15SE 1170 rpm

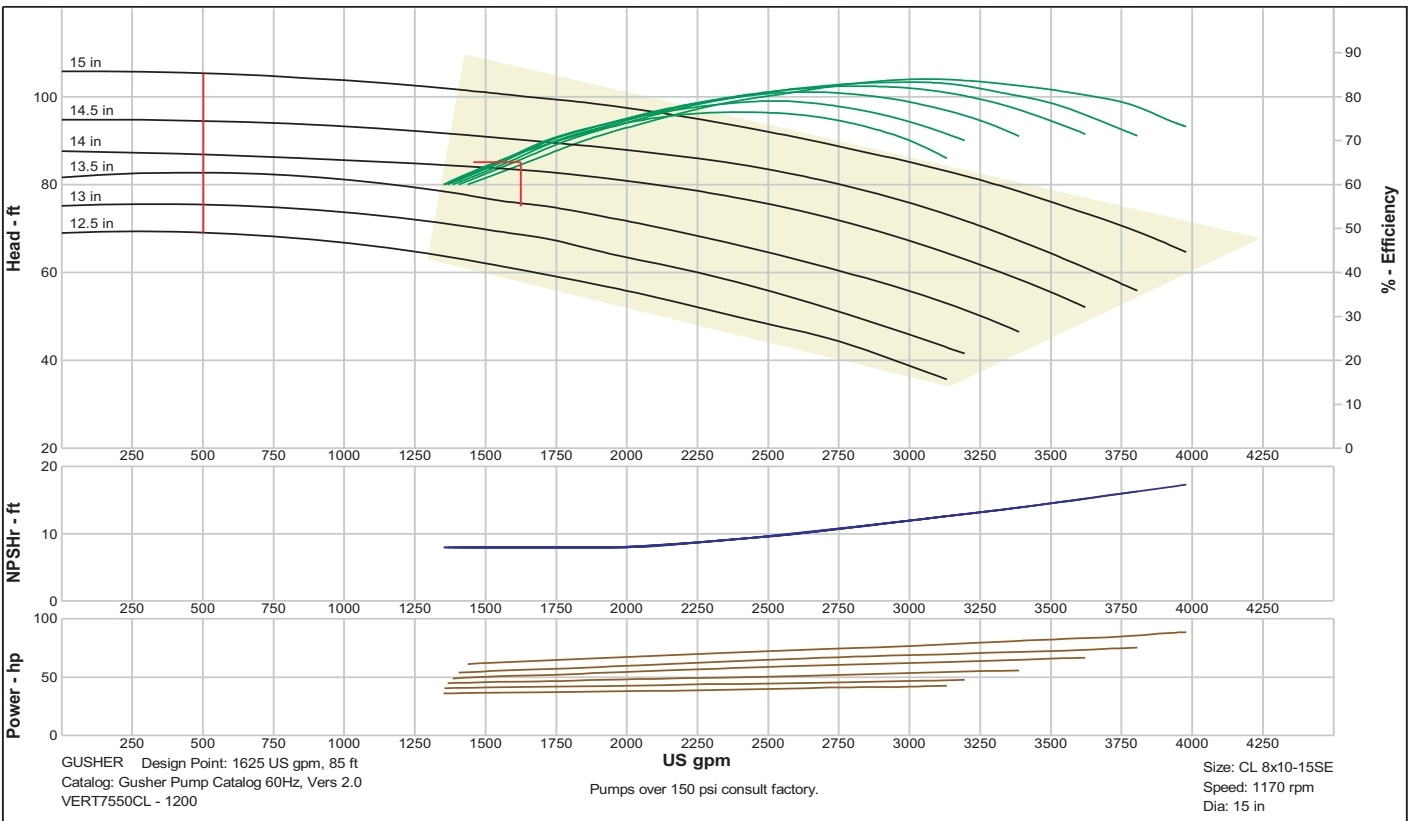

Pump Selection Curves

7071L CL 8x10-15BSE 1765 rpm

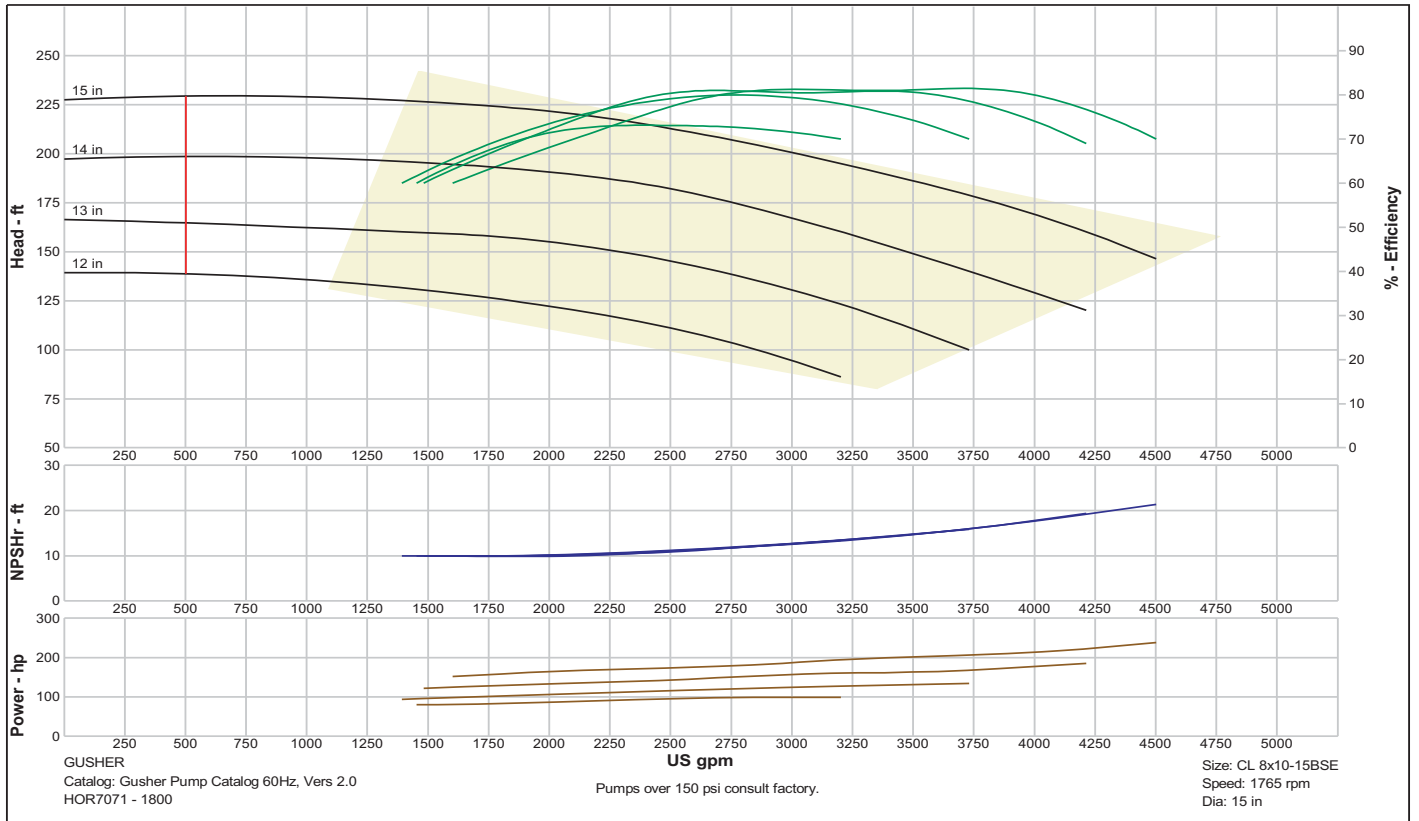

7071L CL 3x4-16SE 1765 rpm

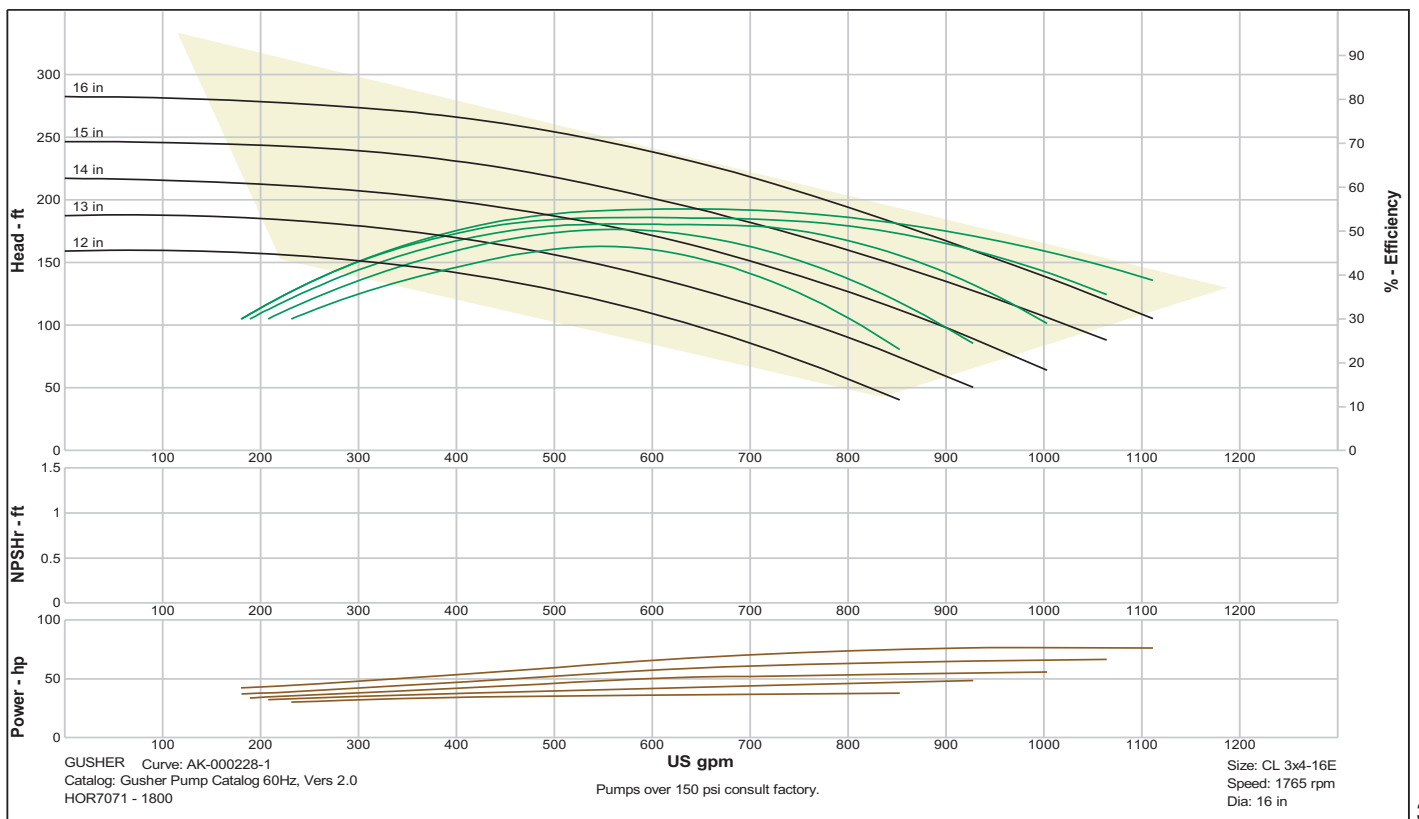

Pump Selection Curves

7071L CL 5x6-16SE 1765 rpm

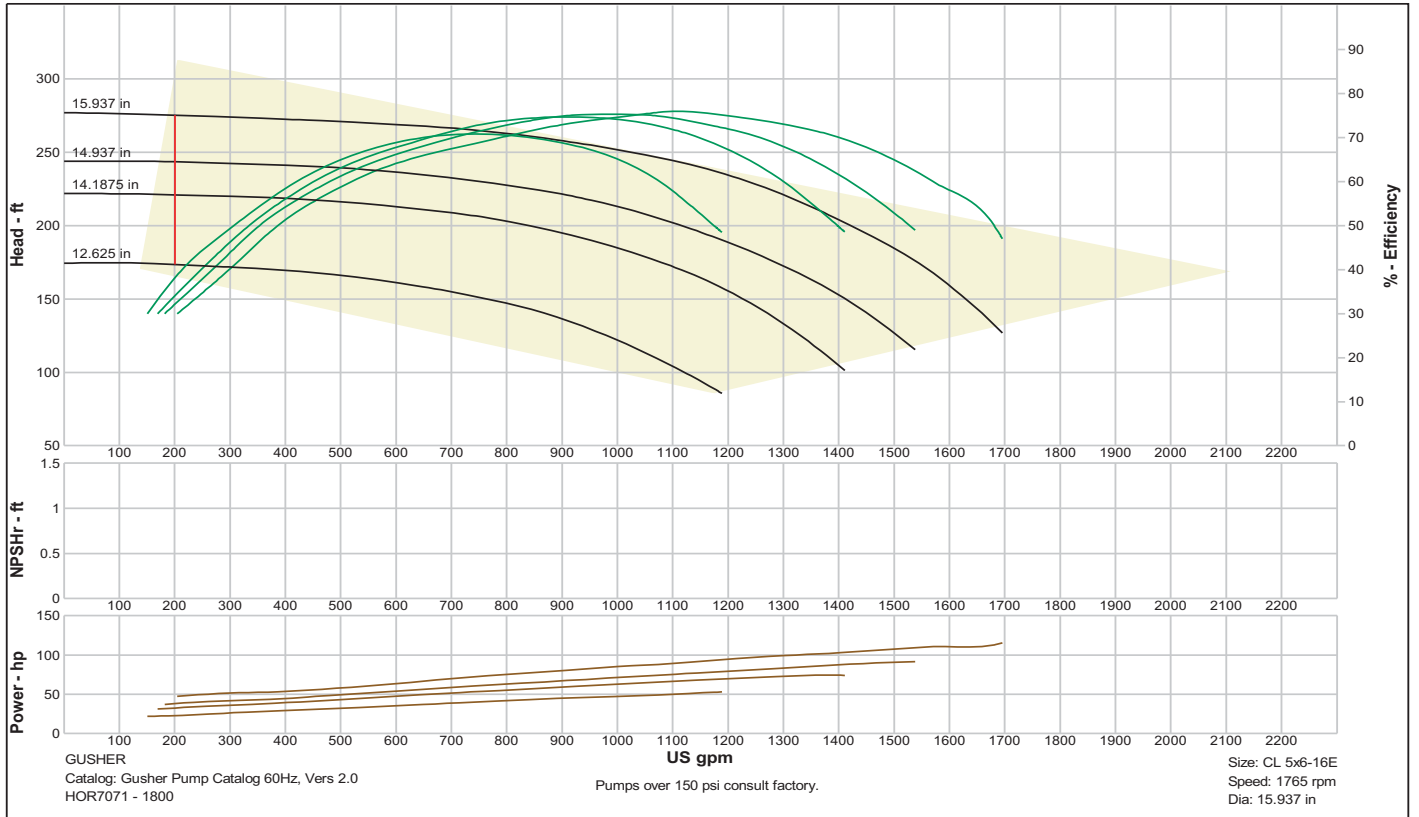

7071L CL 4x6-17E 1780 rpm

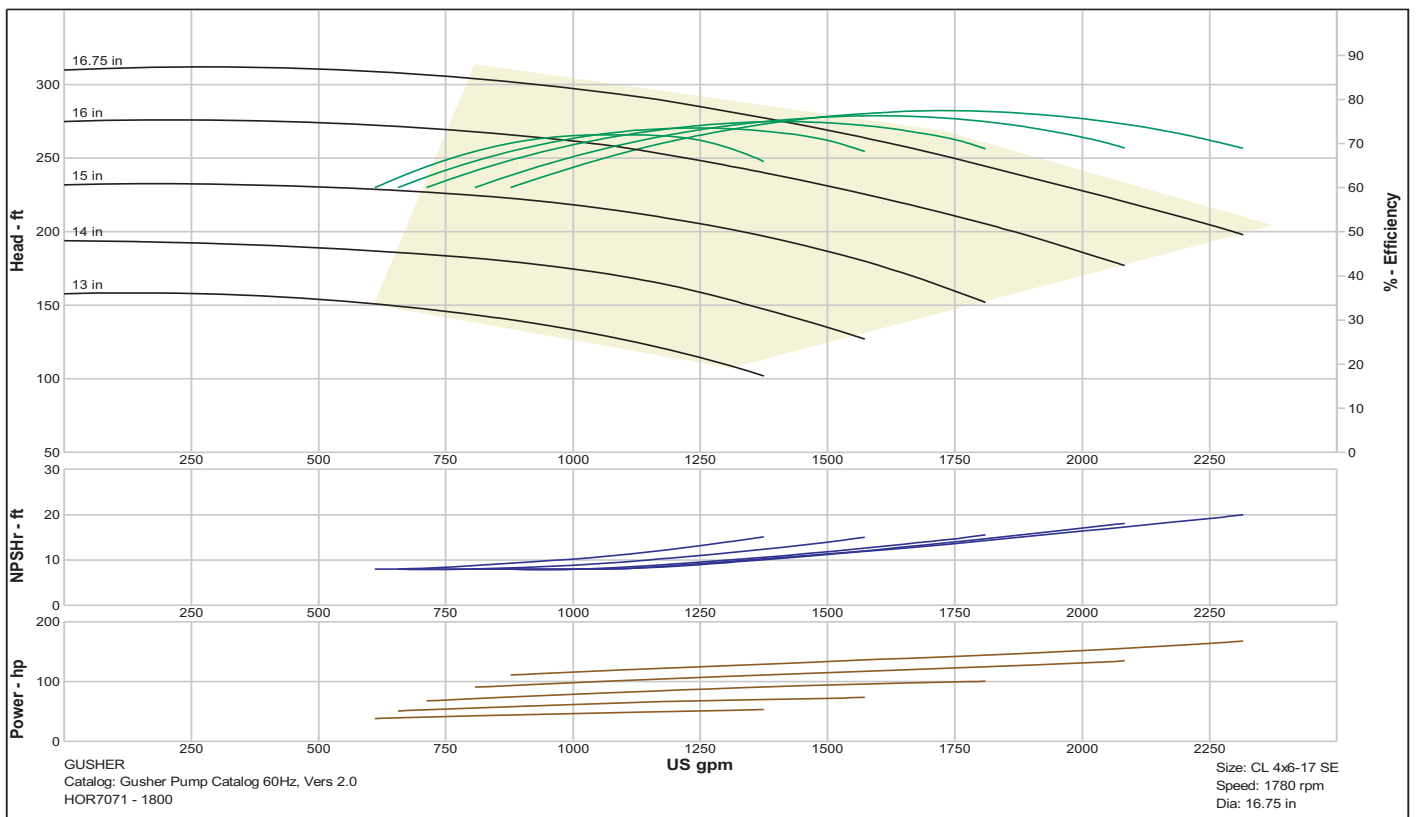

Pump Selection Curves

7071L CL 6x8-17E 1780 rpm

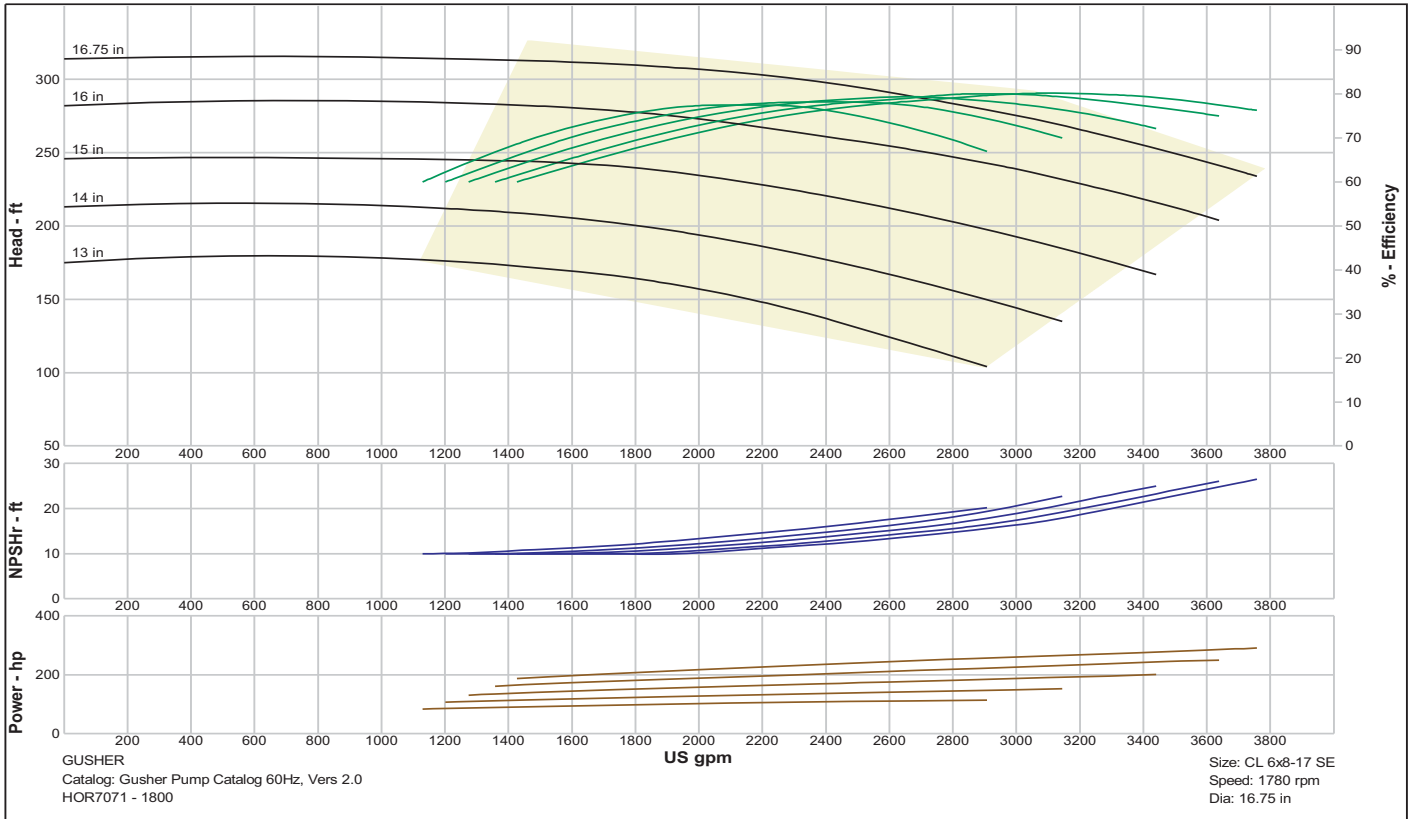

7071L CL 8x10-17SE 1765 rpm

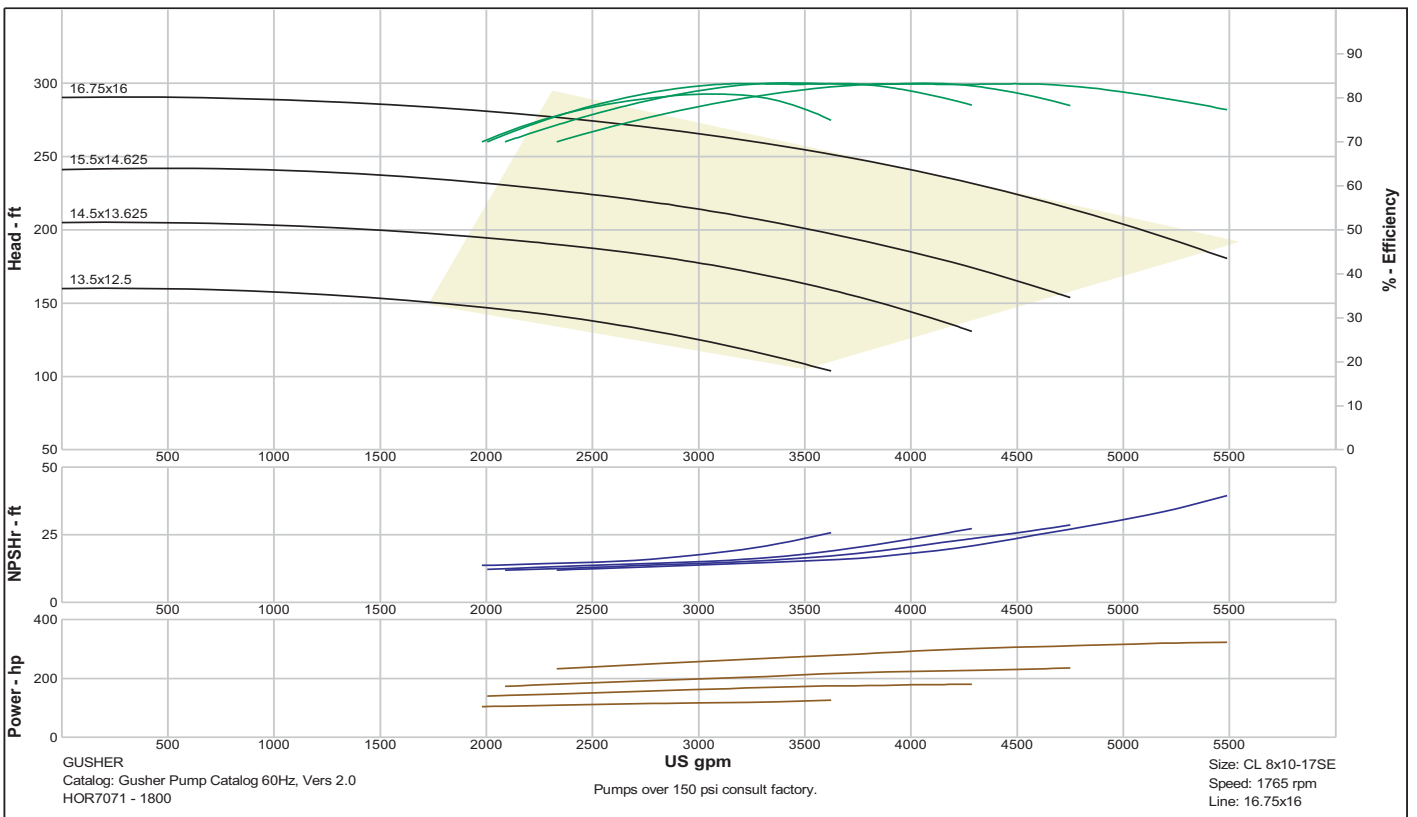

Ordering Information

Order the Gusher 7071 Series Pump to meet your needs by model number. The model number should be specified as follows:

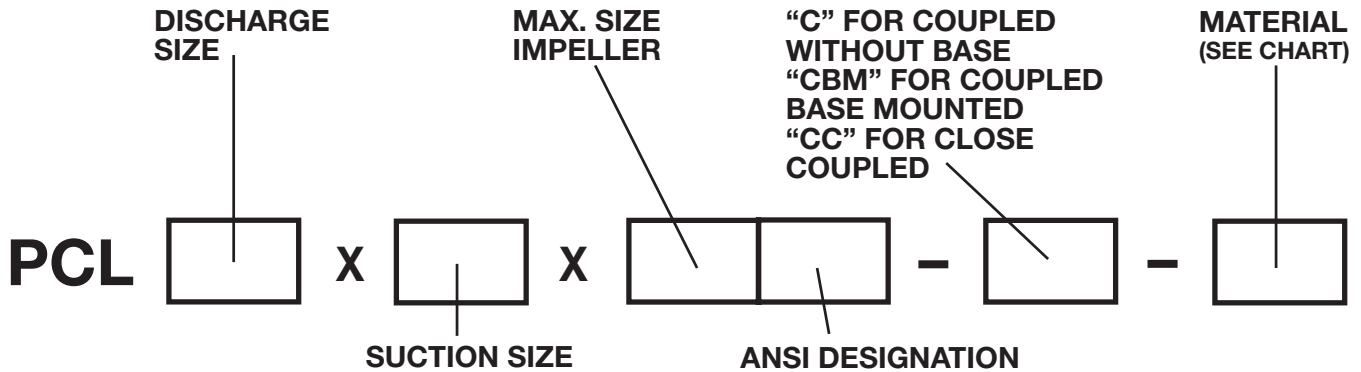

EXAMPLE: For ordering a Coupled Base Mounted Pump with a 1" discharge and a 1 1/2" diameter suction with impeller of 6" maximum. Ductile iron construction. The model number for ordering description would be: **PCL-1 x 1 1/2-6AA-CBM-A**

Standard Materials of Construction

Material Designation	Type	Description
A	All Ductile	Ductile Iron Construction
B	Stainless Steel	316 Stainless Steel Wetted Parts
C	Stainless Steel Fitted	316 Stainless Steel Shaft and Impeller

Other Materials are Available

Material Designation	Type
CD4	All CD4M construction
A20	All Alloy 20 construction
M	All Monel construction
H	Hast B or C construction, specify

Motor Specifications

Please furnish the following information on all orders: Horsepower, Frame Size, Voltage, RPM, Hertz and Phase. If a special motor is required specify.

The **Base Mounted Pump** is designed to accept a Nema Frame Foot Mounted Motor.

Note: If motor is ordered it will be factory mounted unless specified.

We Can Help

Our engineering department will help you select the proper pump for your application. Call, write or email. Performance Curves are available on all pumps.

Call about our Quick Ship Program.

Gusher Pumps

115 Industrial Drive
Williamstown, KY 41097

Phone: 859-824-3100

Fax: 859-824-7248

Web: www.gusher.com



A RUTHMAN COMPANY

**Gusher Pumps is a Division of
Ruthman Companies
Corporate Headquarters**

1212 Streng Street
Cincinnati, OH 45233
Phone: 513-559-1901
Fax: 513-559-0035
Web: www.ruthmancompanies.com

Gusher Pumps of Dry Ridge

22 Ruthman Drive
Dry Ridge, KY 41035
Phone: 859-824-5001
Fax: 859-824-3011
Web: www.gusher.com

Gusher Pumps of Williamstown

115 Industrial Drive
Williamstown, KY 41097
Phone: 859-824-3100
Fax: 859-824-7248
Web: www.gusher.com

Gusher Pumps of Cincinnati

1212 Streng Street
Cincinnati, OH 45233
Phone: 513-559-1901
Fax: 513-559-0035
Web: www.gusher.com

Gusher Pumps of California

8226 Salt Lake Avenue
Cudahy, CA 90201
Phone: 323-773-0847
Fax: 323-773-0958
Email: gusherca@aol.com

Gusher Pumps of New Castle

403 North Ninth Street
New Castle, IN 47362
Phone: 765-529-5624
Fax: 765-521-0008
Email: gusherpump@insightbb.com

BSM Pump Corp.

180 Frenchtown Road
North Kingstown, RI 02852
Phone: 401-471-6350
Fax: 401-471-6370
Web: www.bsmpump.com

Nagle Pumps

1249 Center Avenue
Chicago Heights, IL 60411
Phone: 708-754-2940
Fax: 708-754-2944
Web: www.naglepumps.com

Wagner Processing - Bay Area

23510 Bernhardt Street
Hayward, CA 94545
Phone: 510-786-3929
Fax: 510-786-3722
Web: www.wagnerprocess.com

Ruthman... Another Word for Innovation



It began in 1913, servicing mechanical components of the steamboats on the Ohio River. The company founder, Alois Ruthman, was a man of vision and saw part of the future of the company was in the development of a reliable industrial pump.

In 1924, with the conception of the first vertical ball bearing sealless centrifugal pump, Ruthman Pump and Engineering furthered the design on a unit with a one piece motor driven shaft. The pump was called "Gusher", giving birth to the trade name Gusher Pumps, and the coining of the term "coolant pump".

Wanting to carry on the tradition of quality and reliability started by his father, Thomas R. Ruthman joined the company in 1949. In the early 1990's Thomas R. Ruthman's son, Thomas G. Ruthman joined the company, continuing this same tradition. Maintaining the reputation of Gusher Pumps by innovation and customer service, the company has grown to service companies worldwide.

Wagner Processing - Central Valley

3675 N. Wilcox Street #C
Stockton, CA 95215
Phone: 209-931-0100
Fax: 209-931-7910
Web: www.wagnerprocess.com

Great Lakes Pump & Supply Co.

1075 Naughton
Troy, MI 48083
Phone: 248-528-9100
Fax: 248-528-9015
Web: www.greatlakespump.com

Process Systems, Inc.

Michigan, Main Headquarters
23633 Pinewood
Warren, MI 48091
Phone: 586-757-5711
Fax: 586-758-6996
Web: www.INFO@psi4pumps.com

Indiana
485 N State Route 341 South
Mellott, IN 47958
Phone: 765-295-2206
Fax: 765-295-2243
Web: www.process-systems-inc.com

Worldwide:

Ruthmann Pumpen

Northberger Strabe 60
Eschweiler Germany D-52249
Phone: +49 (0) 2403 5595 0
Fax: +49 (0) 2403 5595 20
Web: www.ruthmannpumpen.de

Birmingham Pump

Unit 7 Network Park
Duddeston Mill Road
Saltley, Birmingham England B81AU
Phone: +44 (0) 121 503 3000
Fax: +44 (0) 121 503 3002
Web: www.birminghampumps.co.uk

**Guan Shen Industrial Pumps
(Shanghai) Company**

广申工业泵(上海)有限公司
Gusher Pumps (Shanghai) Co., Ltd.
Building D, Room 416
No. 188 East Jiagwan Road
Shanghai, 200081
P.R. CHINA
上海市东江湾路 188 号 D 栋 416 室
Phone: 86-21-33872056
Phone: 86-21-33872058
Fax: 86-21-33872057

电话: 86-21-33872056
86-21-33872058
传真: 86-21-33872057



**RUTHMAN
COMPANIES**